

*5455*  
*LDD 150*  
JP5500  
**3360DNP**

## Operating Instructions

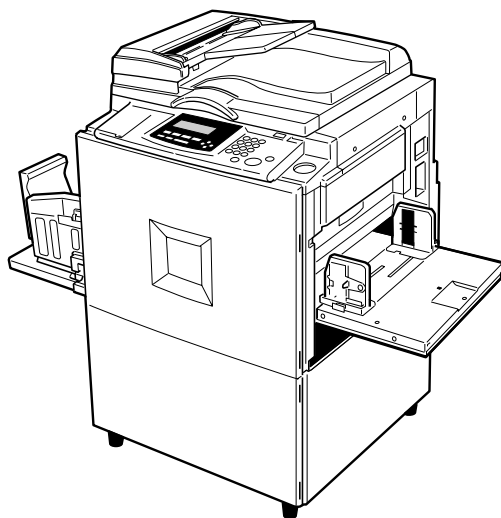

For safety, please read this manual carefully before you use this product and keep it handy for future reference.

## Introduction

This manual describes detailed instructions on the operation and notes about the use of this machine. To get maximum versatility from this machine all operators are requested to read this manual carefully and follow the instructions. Please keep this manual in a handy place near the machine.



### Notes:

Some illustrations in this manual might be slightly different from the machine.  
Certain options might not be available in some countries. For details, please contact your local dealer.



Two kinds of size notation are employed in this manual. With this machine refer to the inch version.

For good print quality, the supplier recommends that you use genuine master and ink from the supplier.

The supplier shall not be responsible for any damage or expense that might result from the use of parts other than genuine parts from the supplier with your office products.

### Power Source

120V, 60Hz, 3.2A or more

Please be sure to connect the power cord to a power source as above. For details about power source, see p.196 "Power Connection".

## Note to users in the United States of America

### Notice:

This equipment has been tested and found to comply with the limits for a Class B digital device, pursuant to Part 15 of the FCC Rules. These limits are designed to provide reasonable protection against harmful interference in a residential installation. This equipment generates, uses and can radiate radio frequency energy and, if not installed and used in accordance with the instructions, may cause harmful interference to radio communications. However, there is no guarantee that interference will not occur in a particular installation. If this equipment does cause harmful interference to radio or television reception, which can be determined by turning the equipment off and on, the user is encouraged to try to correct the interference by one more of the following measures:

**Reorient or relocate the receiving antenna.**

**Increase the separation between the equipment and receiver.**

**Connect the equipment into an outlet on a circuit different from that to which the receiver is connected.**

**Consult the dealer or an experienced radio /TV technician for help.**

### Warning

Changes or modifications not expressly approved by the party responsible for compliance could void the user's authority to operate the equipment.

## Note to users in Canada

### Note:

This Class B digital apparatus complies with Canadian ICES-003.

### Remarque concernant les utilisateurs au Canada

### Avertissement:

Cet appareil numérique de la classe B est conforme à la norme NMB-003 du Canada.

In accordance with IEC 60417, this machine uses the following symbols for the main switch:

**I** means POWER ON.

**O** means POWER OFF.

## Introduction

This manual describes detailed instructions on the operation and notes about the use of this machine. To get maximum versatility from this machine all operators are requested to read this manual carefully and follow the instructions. Please keep this manual in a handy place near the machine.



### Notes:

Some illustrations in this manual might be slightly different from the machine.  
Certain options might not be available in some countries. For details, please contact your local dealer.



Two kinds of size notation are employed in this manual. With this machine refer to the inch version.

For good print quality, Standard recommends that you use genuine Standard masters and inks.

Standard shall not be responsible for any damage or expense that might result from the use of parts other than genuine Standard parts in your Standard office product.

### Power Source

120V, 60Hz, 3.2A or more

Please be sure to connect the power cord to a power source as above. For details about power source, ⇒ p.196 "Power Connection".

# Safety Information

When using this machine, the following safety precautions should always be followed.

---

## Safety During Operation

---

In this manual, the following important symbols are used:

**⚠ WARNING:**  
*Indicates a potentially hazardous situation which, if instructions are not followed, could result in death or serious injury.*

**⚠ CAUTION:**  
*Indicates a potentially hazardous situation which, if instructions are not followed, may result in minor or moderate injury or damage to property.*

---

### **⚠ WARNING:**

---

- **Connect the power cord directly into a wall outlet and never use an extension cord.**
- **Disconnect the power plug (by pulling the plug, not the cable) if the power cable or plug becomes frayed or otherwise damaged.**
- **To avoid hazardous electric shock, do not remove any covers or screws other than those specified in this manual.**
- **Turn off the power and disconnect the power plug (by pulling the plug, not the cable) if any of the following occurs:**
  - **You spill something into the machine.**
  - **You suspect that your machine needs service or repair.**
  - **The external housing of your machine has been damaged.**

---

**⚠ CAUTION:**

---

- *Protect the machine from dampness or wet weather, such as rain, snow.*
- *Unplug the power cord from the wall outlet before you move the machine. While moving the machine, you should take care that the power cord will not be damaged under the machine.*
- *When you disconnect the power plug from the wall outlet, always pull the plug (not the cable).*
- *Do not allow paper clips, staples, or other small metallic objects to fall inside the machine.*
- *For environmental reasons, do not dispose of the machine or expended supply waste at household waste collection points. Disposal can take place at an authorized dealer.*
- *Be careful not to cut yourself on any sharp edges when you reach inside the machine to remove misfed sheets of paper or masters.*
- *Our products are engineered to meet high standards of quality and functionality, and we recommend that you use only the expendable supplies available at an authorized dealer.*

# How to Read This Manual

---

## Symbols

---

In this manual, the following symbols are used:

 **WARNING:**

This symbol indicates a potentially hazardous situation that might result in death or serious injury when you misuse the machine without following the instructions under this symbol. Be sure to read the instructions, all of which are described in the Safety Information section.

 **CAUTION:**

This symbol indicates a potentially hazardous situation that might result in minor or moderate injury or property damage that does not involve personal injury when you misuse the machine without following the instructions under this symbol. Be sure to read the instructions, all of which are described in the Safety Information section.

\* The statements above are notes for your safety.

 **Important**

If this instruction is not followed, paper might be misfed, originals might be damaged, or data might be lost. Be sure to read this.

 **Preparation**

This symbol indicates the prior knowledge or preparations required before operating the machine.

 **Note**

This symbol indicates precautions for operation, or actions to take after misoperation.

 **Limitation**

This symbol indicates numerical limits, functions that cannot be used together, or conditions in which a particular function cannot be used.

 **Reference**

This symbol indicates a reference.

[    ]

Keys that appear on the machine's display panel.

[    ]

Keys built into the machine's operation panel.

# Making Prints

Before making prints using this machine, you have to make a master by pressing the **[Start]** key. When you press the **[Start]** key, the machine scans the original image and makes a master. This procedure describes how to make basic prints.

**1** Place your originals in one of the following two ways:

Placing originals on the exposure glass

**1** Place a single page face down.

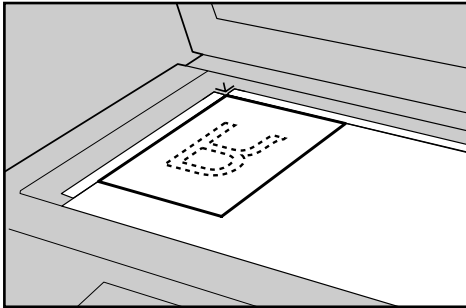

ZDCH110E

Inserting originals in the optional document feeder

**1** Insert a stack of originals face up.

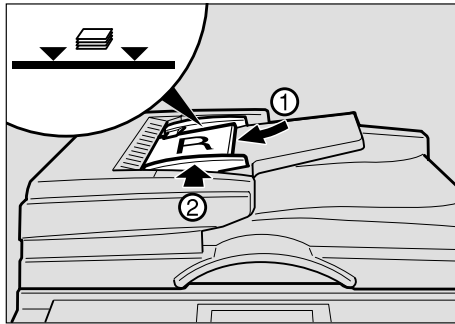

ZDCH120E

**Note**

- To avoid jamming, fan the originals before placing them in the document feeder.

**2** Press the **[Start]** key.

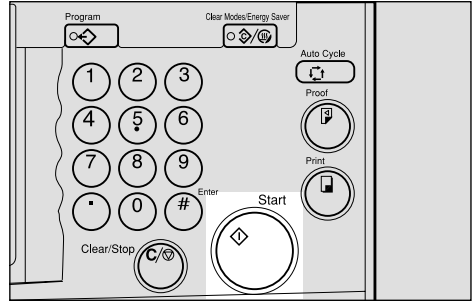

ZBHS280N

**3** Press the **[Proof]** key.

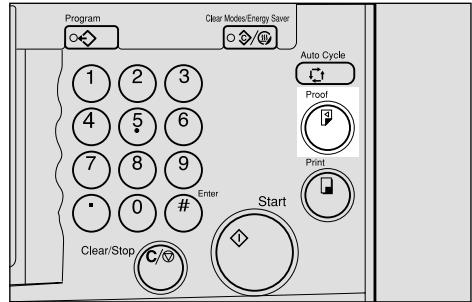

ZBHS290N

Check the print image.

**Reference**

For changing the image position, see p.24 "Adjusting the Position of Printed Images".

Ready for Master Making/ Printing			
	11x17		0.00in.
Letter	100%	Std.	0.00in.
Original	Ratio	Ppr.Type	Image

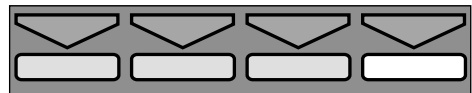

TPES560E

To increase the image density, press the **[<]** key. See p.25 "Adjusting the Image Density of Prints".



To decrease the image density, press the **[▶]** key. See p.25 “Adjusting the Image Density of Prints”.

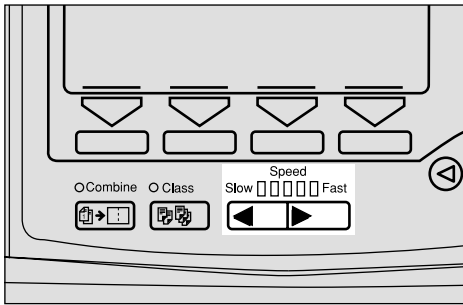

**4** Enter the desired number of prints with the number keys.

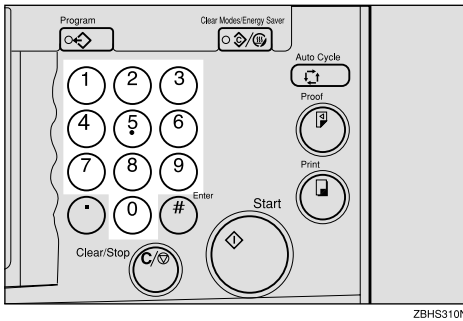

**5** Press the **[Print]** key.

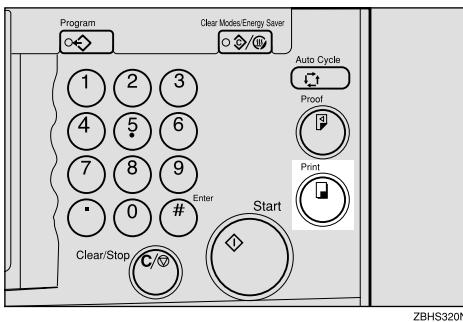

When the print job has finished, press the **[Clear Modes/Energy Saver]** key. Previously entered job settings will be cleared.

# What You Can do with this Machine

Below is a quick summary of this machine's features and where to look in this manual for more information.

## ❖ Standard Printing

See p.19 "Standard Printing".

## ❖ Energy Saver Mode

See p.22 "Energy Saver Mode".

## ❖ Adjusting the Print Image Position

See p.24 "Adjusting the Position of Printed Images".

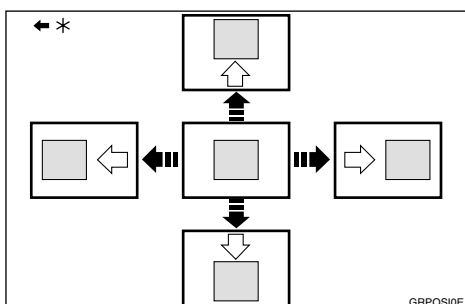

\* Paper feed direction

## ❖ Adjusting the Print Image Density

See p.25 "Adjusting the Image Density of Prints".

## ❖ Tint Mode

See p.26 "Tint Mode".

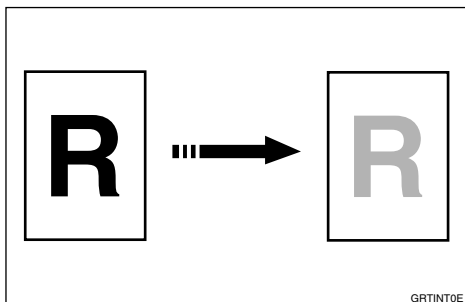

## ❖ Changing the Printing Speed

See p.27 "Changing the Printing Speed".

## ❖ Reducing and Enlarging Using Preset Ratios

See p.29 "Reducing and Enlarging Using Preset Ratios".

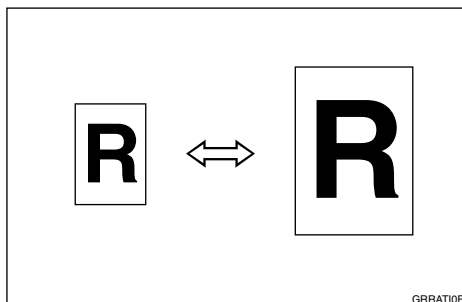

## ❖ Auto Magnification

See p.31 "Auto Magnification".

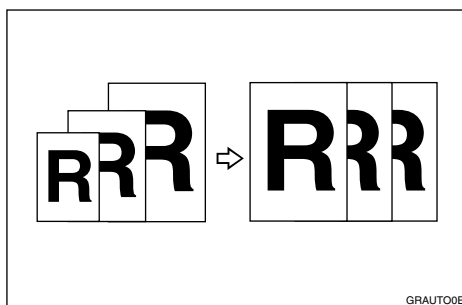

## ❖ Zoom

See p.34 "Zoom".

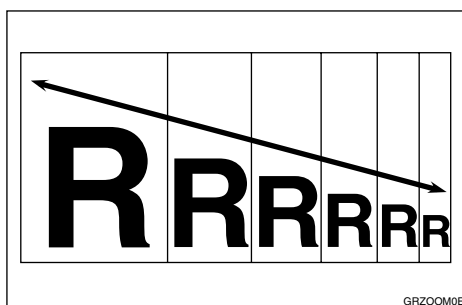

❖ **Directional Magnification (%)**

See p.36 “Directional Magnification (%)”.

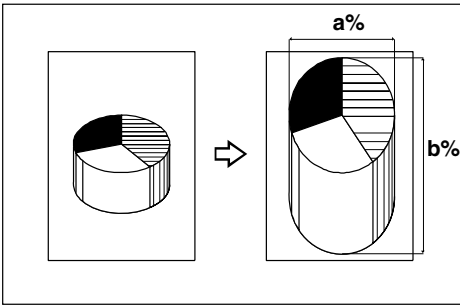

CP2P01EE

❖ **Directional Magnification (Size)**

See p.38 “Directional Magnification (Size)”.

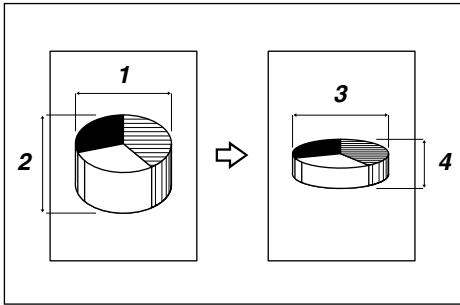

CP2M01EE

❖ **Erasing Center and Edge Margins**

See p.40 “Erasing Center and Edge Margins”.

❖ **Edge Erase**

See p.41 “Edge Erase”.

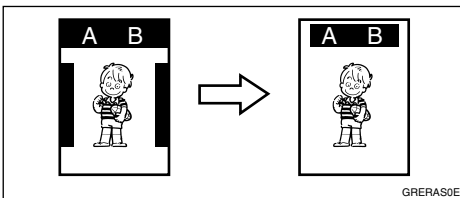

GRERAS0E

❖ **Printing on Various Kinds of Paper**

See p.43 “Printing onto Various Kinds of Paper”.

❖ **Selecting Original Modes**

See p.46 “Selecting Original Modes”.

❖ **Economy Mode**

See p.50 “Economy Mode”.

❖ **Auto Cycle**

See p.51 “Auto Cycle”.

❖ **All Class Mode**

See p.52 “All Class Mode”.

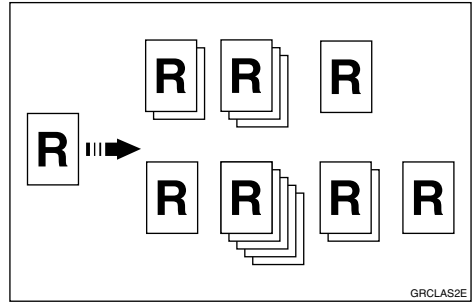

GRCLAS2E

❖ **Auto Class Mode**

See p.54 “Auto Class Mode”.

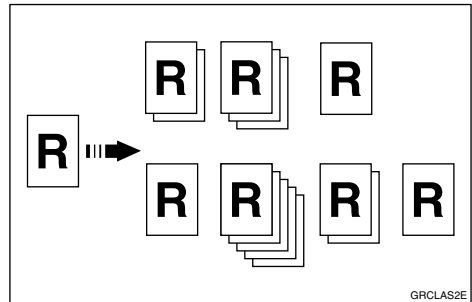

GRCLAS2E

❖ **Manual Class Mode**

See p.57 “Manual Class Mode with One Original”.

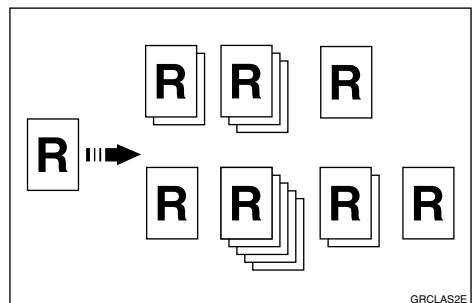

GRCLAS2E

❖ **Manual Class Mode with two or More Originals**

See p.59 “Manual Class Mode with two or More Originals”.

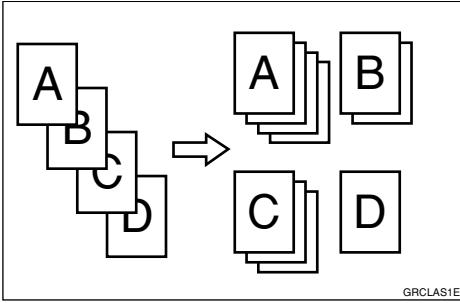

❖ **Class Mode**

See p.61 “Class Mode”.

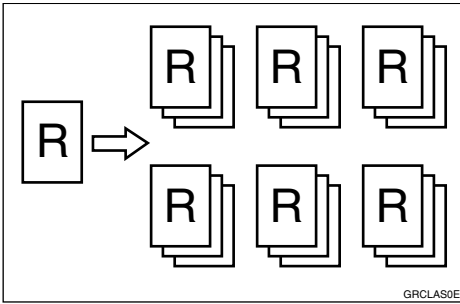

❖ **Combining Originals**

See p.63 “Combine Originals”.

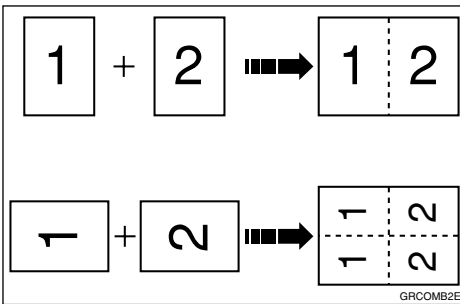

❖ **Auto Combine Mode**

See p.68 “Auto Combine Mode”.

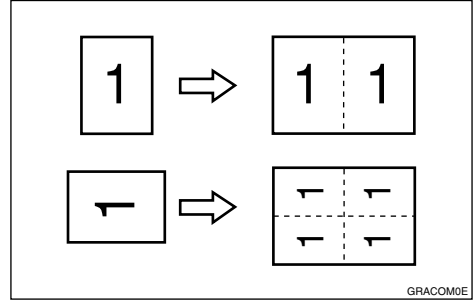

❖ **Skip Feed Printing**

See p.70 “Skip Feed Printing”.

❖ **Programs**

See p.72 “Programs”.

❖ **Security Mode**

See p.75 “Security Mode”.

❖ **Quality Start Mode**

See p.76 “Quality Start Mode”.

❖ **Job Separation**

See p.77 “Job Separation”.

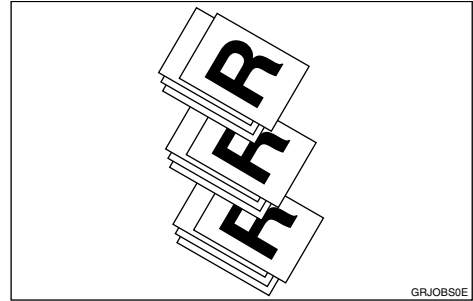

❖ **Conserving the Master**

See p.79 “Conserving the Master”.

❖ **On Line Printing**

See p.80 “On Line Printing”.

❖ **Making Color Prints**

See p.130 “Making Color Prints”.

❖ **Printing in Two Colors**

See p.132 “Printing in Two Colors”.

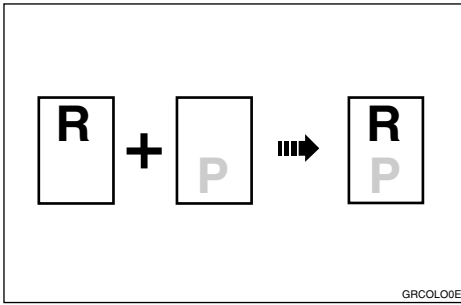

❖ **Date Stamp**

See p.108 “Date Stamp”.

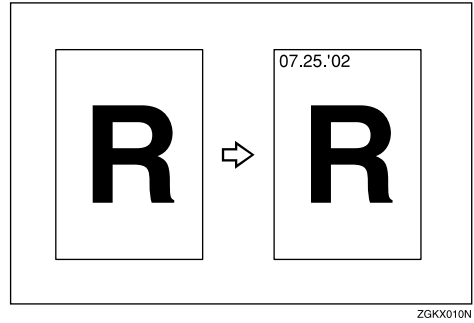

❖ **Image Rotation**

See p.82 “Image Rotation”.

❖ **Make-up Printing**

See p.94 “Make-up Printing”.

❖ **Merging Images**

See p.105 “Image Overlay”.

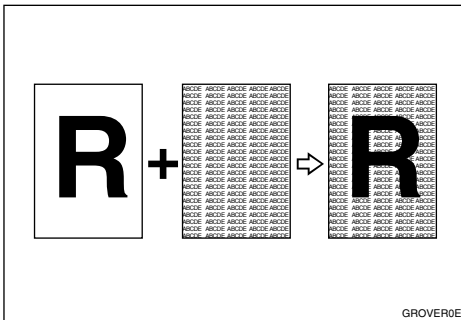

❖ **Page Stamp**

See p.110 “Page Stamp”.

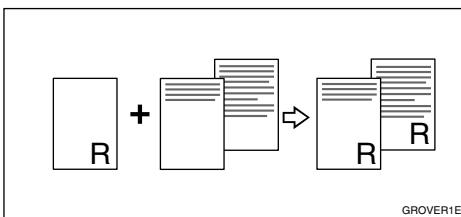
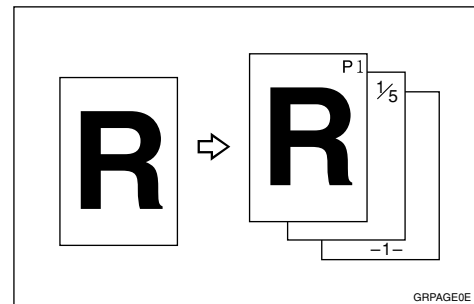

❖ **Stamp**

See p.113 “Stamp”.

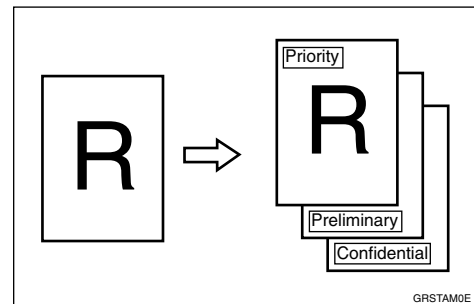

❖ **Memory Combine**

See p.115 “Memory Combine”.

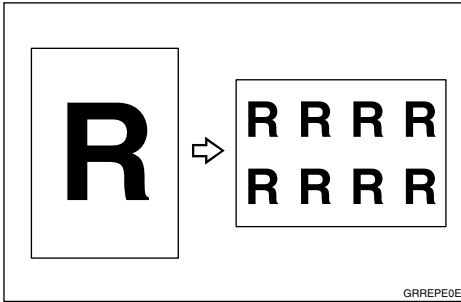
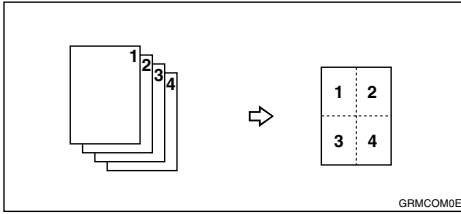

❖ **Original Storage**

See p.100 “Original Storage”.

❖ **Storage Overlay**

See p.105 “Image Overlay”.

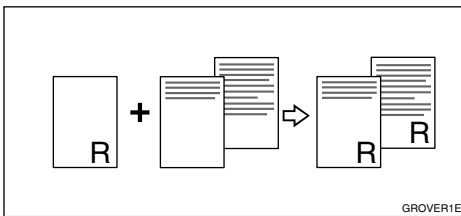
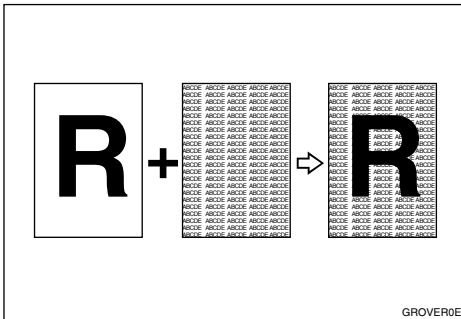

# TABLE OF CONTENTS

<b>Machine Exterior</b> .....	<b>1</b>
<b>Machine Interior</b> .....	<b>2</b>
<b>Options</b> .....	<b>4</b>
<b>Operation Panel</b> .....	<b>6</b>
Keys.....	6
Indicators.....	8
<b>Panel Display</b> .....	<b>9</b>
Panel Display Layout.....	10

## **1. Operation**

---

<b>Print Paper</b> .....	<b>11</b>
<b>Originals</b> .....	<b>13</b>
<b>Printing Preparations</b> .....	<b>15</b>
Loading Paper.....	15
Setting Up The Paper Delivery Tray.....	16
<b>Entering a User Code to Use the Machine</b> .....	<b>18</b>
<b>Standard Printing</b> .....	<b>19</b>
Removing Prints.....	20
<b>Energy Saver Mode</b> .....	<b>22</b>
<b>Auto Reset</b> .....	<b>23</b>
<b>Adjusting the Position of Printed Images</b> .....	<b>24</b>
<b>Adjusting the Image Density of Prints</b> .....	<b>25</b>
Before Making a Master.....	25
After Making a Master.....	25
<b>Tint Mode</b> .....	<b>26</b>
<b>Changing the Printing Speed</b> .....	<b>27</b>
<b>Stopping a Multi-print Run</b> .....	<b>28</b>
Stopping a Multi-print Run to Print Another Original.....	28
Changing the Number of Prints Entered and Checking Completed Prints...	28
<b>Reducing and Enlarging Using Preset Ratios</b> .....	<b>29</b>
<b>Auto Magnification</b> .....	<b>31</b>
<b>Zoom</b> .....	<b>34</b>
<b>Directional Magnification (%)</b> .....	<b>36</b>
<b>Directional Magnification (Size)</b> .....	<b>38</b>
<b>Erasing Center and Edge Margins</b> .....	<b>40</b>
<b>Edge Erase</b> .....	<b>41</b>

<b>Printing onto Various Kinds of Paper</b> .....	<b>43</b>
Printing onto Thick Paper.....	43
Printing onto Standard Paper.....	43
Printing onto Envelopes.....	44
Printing onto Special Kinds of Paper.....	44
<b>Selecting Original Modes</b> .....	<b>46</b>
Letter/Photo Mode Printing.....	46
Photo Mode Printing.....	47
Pencil Mode Printing.....	48
<b>Economy Mode</b> .....	<b>50</b>
<b>Auto Cycle</b> .....	<b>51</b>
<b>All Class Mode</b> .....	<b>52</b>
<b>Auto Class Mode</b> .....	<b>54</b>
<b>Manual Class Mode with One Original</b> .....	<b>57</b>
<b>Manual Class Mode with two or More Originals</b> .....	<b>59</b>
<b>Class Mode</b> .....	<b>61</b>
<b>Combine Originals</b> .....	<b>63</b>
<b>Auto Combine Mode</b> .....	<b>68</b>
<b>Skip Feed Printing</b> .....	<b>70</b>
<b>Programs</b> .....	<b>72</b>
Storing a Program.....	72
Protecting a Program.....	73
Removing Program Protection.....	73
Recalling a Program.....	74
<b>Security Mode</b> .....	<b>75</b>
<b>Quality Start Mode</b> .....	<b>76</b>
Using Quality Start Manually.....	76
<b>Job Separation</b> .....	<b>77</b>
<b>Conserving the Master</b> .....	<b>79</b>
<b>On Line Printing</b> .....	<b>80</b>
Auto On Line.....	81
<b>Image Rotation</b> .....	<b>82</b>
<b>Make-up Printing Features</b> .....	<b>83</b>
Main Features.....	83
Make-up Modes for Designated Areas.....	83
Make-up Modes for Outside Designated Areas.....	85
Background Patterns.....	86
<b>Command Sheets for Make-Up Printing</b> .....	<b>87</b>
Command Sheets.....	87
Making a Command Sheet.....	87
Command Sheets and Finished Prints.....	92



<b>Make-up Printing .....</b>	<b>94</b>
<b>Make-up Samples .....</b>	<b>97</b>
<b>Original Storage.....</b>	<b>100</b>
Storing Originals.....	100
Selecting Stored Originals.....	102
Protecting Stored Originals .....	102
Deleting Stored Originals .....	103
<b>Image Overlay .....</b>	<b>105</b>
Storage Overlay .....	105
On Line Overlay .....	106
Overlay Format .....	106
<b>Date Stamp.....</b>	<b>108</b>
<b>Page Stamp.....</b>	<b>110</b>
<b>Stamp.....</b>	<b>113</b>
<b>Memory Combine .....</b>	<b>115</b>
Combining onto a Single-sided Print .....	115
Repeat.....	120

## **2. Optional Functions**

---

<b>Optional Document Feeder.....</b>	<b>125</b>
Originals .....	125
Placing Originals .....	126
Combine Printing.....	127
Manual Class Mode with Two or More Originals.....	128
<b>Color Printing Using the Optional Color Drum.....</b>	<b>130</b>
Making Color Prints.....	130
Changing the Color Drum Unit .....	130
Printing in Two Colors .....	132
<b>Changing the Drum Size .....</b>	<b>134</b>
Printing Area (At 23°C/73°F, 65% RH).....	134
Master Cut Length.....	134

## **3. Combination Chart**

---

<b>Combination Chart .....</b>	<b>135</b>
--------------------------------	------------

## 4. User Tools

---

<b>Accessing the User Tools.....</b>	<b>139</b>
<b>User Tools Menu.....</b>	<b>141</b>
1. System .....	141
2. Set Operat'n Mode .....	142
3. Initial Setting.....	143
4. Mode Setting .....	144
5. Stamp.....	148
6. Administrator Mode .....	150
7. On Line Mode.....	151
<b>User Tool Menus in Detail.....</b>	<b>153</b>
1-6 Time Setting.....	153
3-4 Reproduction Ratio .....	154
3-5 Class Enter No.....	154
3-11 Margin Erase Area.....	155
4-11 No. of Skip Feed .....	156
4-14 No. of Q.start.....	157
4-19 Type of Paper .....	158
5-4 Stamp Position .....	159
5-7 Position (Date) .....	160
5-10 Position (Page) .....	161
5-11 Make/Chg. Pattern.....	163
6-1 Check Counter .....	164
6-2 Reset Counters .....	164
6-5 Chg. User Code .....	165
6-6 Del. User Code .....	166

## 5. Troubleshooting

---

<b>If Your Machine Does Not Operate as You Want.....</b>	<b>167</b>
<b>If You Cannot Make Prints as You Want .....</b>	<b>169</b>
Combine Originals Mode.....	169
<b>Loading Paper.....</b>	<b>170</b>
<b>☞ Clearing Misfeeds.....</b>	<b>171</b>
"☞ + A" Paper Misfeeds in the Paper Feed Section.....	171
"☞ + A + B" Paper Misfeeds in the Paper Feed Section .....	172
"☞ + B" Paper or Master Wrapped Around the Drum.....	173
"☞ + C" Paper Misfeeds in the Paper Exit Section.....	175
"☞ + D" Master Misfeeds in the Master Feed Section.....	176
"☞ + D + B" Master Misfeeds in the Master Feed Section .....	176
"☞ + B + E" Master Misfeeds in the Master Eject Section.....	177
"☞ + E" Master Misfeeds in the Master Eject Section .....	178
"☞ + P" Original Misfeeds Occur When Using the Optional Document Feeder ...	179
<b>When the Open Cover/Unit Indicator (☞) Lights.....</b>	<b>181</b>
<b>When the Add Ink Indicator (☞) Lights .....</b>	<b>182</b>

- When the Master End Indicator (🖨️) Lights..... 184**
- When the Master Eject Indicator (🗑️) Lights..... 186**
- When Other Indicators Are Lit..... 187**
- When Prints Are Not Delivered in a Neat Stack..... 188**
  - When Printing on Small Size Paper..... 188
  - When the Machine Cannot Detect the Paper Size..... 188
- Poor Printing..... 189**
  - Dirty Background..... 189
  - Black Lines/Stained Prints ..... 192
  - Faint Prints ..... 192

**6. Remarks**

---

- Do's and Don'ts ..... 193**
- Where to Put Your Machine..... 195**
  - Environment..... 195
  - Power Connection..... 196
  - Machine Clearance ..... 196
- Maintaining Your Machine..... 197**
  - Cleaning the Main Frame..... 197
  - Cleaning the Optional Document Feeder..... 198

**7. Specifications**

---

- Main Frame..... 199**
- Document Feeder (Option) ..... 203**
- Color Drum Type 55(L) A3, 11" × 17" (Option)..... 203**
- Color Drum Type 55(S) A4, 8<sup>1</sup>/<sub>2</sub>" × 11" (Option) ..... 203**
- Exposure Glass Cover (Option) ..... 203**
- Printer Unit Type 80 RCP80 (Option)..... 203**
- Interface Cable Type 85 (Option) ..... 203**
- Editing Function Type 85 (Option)..... 203**
- Twin Color Press Roller Printing System TC-II (Option)..... 204**
- Consumables..... 205**
- INDEX..... 206**



# Machine Exterior

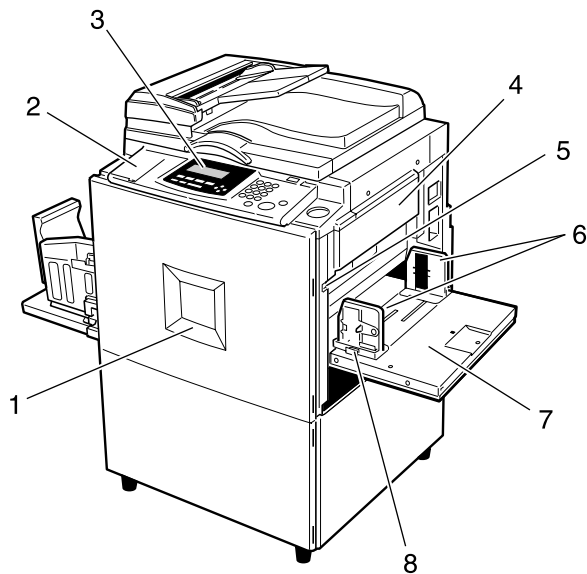

ZFXH020E

## **1. Front door**

Open to access the inside of the machine.

## **2. Flip up cover**

Flip up to access the keys underneath.

## **3. Operation panel**

See p.6 "Operation Panel".

## **4. Master tray**

Open this unit when installing the master.

## **5. Paper feed tray down key**

Press to lower the paper feed tray.

## **6. Paper feed side plates**

Prevent paper skewing.

## **7. Paper feed tray**

Load paper here.

## **8. Paper feed side plates knob**

Use to move the side plates.

# Machine Interior

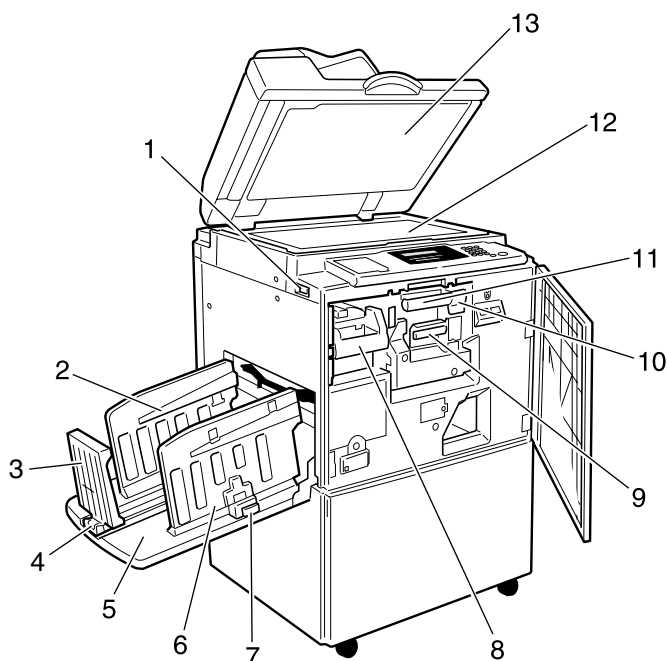

ZBHH180E

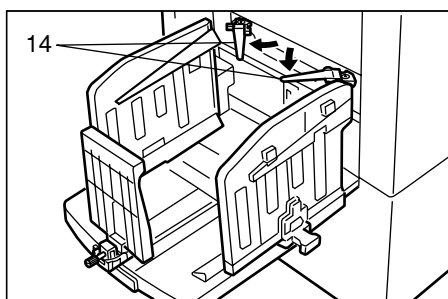

ZDZH120E

## **1. Main switch**

Use to turn the power on or off.

## **2. Paper alignment wings**

Lift or lower the wings depending on the type of paper being used.

## **3. Paper delivery end plate**

This plate aligns the leading edge of prints.

## **4. Paper delivery end plate knob**

Use to move the end plate.

## **5. Paper delivery tray**

Completed prints are delivered here.

## **6. Paper delivery side plates**

These plates align the prints on the paper delivery tray.

## **7. Paper delivery side plate knobs**

Use to move the side plates.

## **8. Handle E1**

Use to pull out the master eject unit.

## **9. Ink holder**

Set the ink cartridge in this holder.

## **10. Drum unit lock lever B1**

Lower to unlock and pull out the drum unit.

## **11. Drum unit**

The master is wrapped around this unit.



## **12. Exposure glass**

Position originals here face down for printing.

## **13. Exposure glass cover or document feeder (option)**

Lower this cover over an original on the exposure glass.

## **14. Trailing edge guides**

Swing out these guides when you use A4, 8<sup>1</sup>/<sub>2</sub>" × 11"   paper.

# Options

## ◆ Exposure glass cover

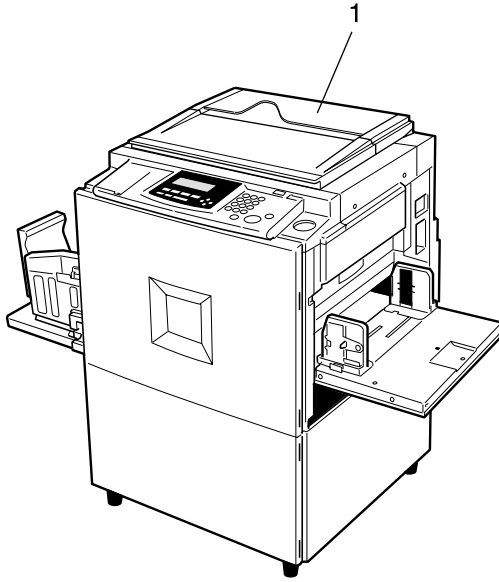

ZFXH040E

## 1. Exposure glass cover

## ◆ Document feeder

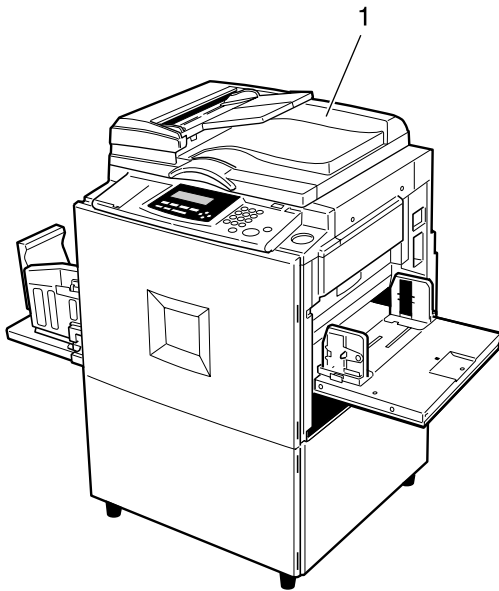

ZFXH030E

## 1. Document Feeder



## ❖ Twin color press roller printing system TC-II

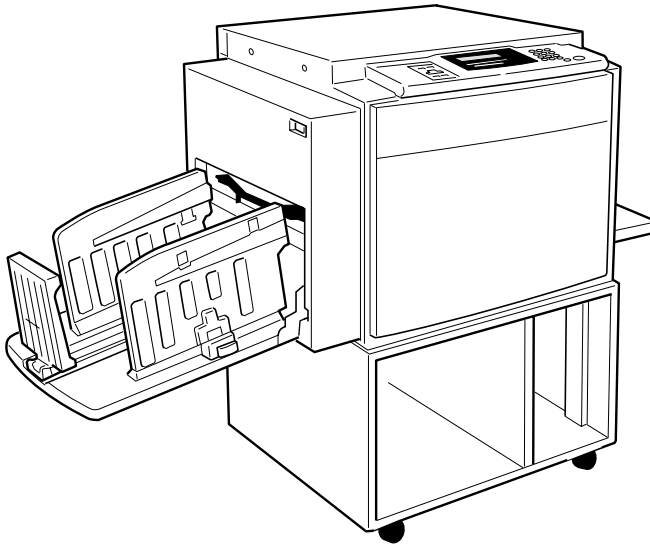

### **Note**

#### Other options:

- Color Drum Type 55(L) A3, 11" × 17"
- Color Drum Type 55(S) A4, 8<sup>1</sup>/<sub>2</sub>" × 11"
- Exposure Glass Cover
- Printer Unit Type 80 RCP80
- Interface Cable Type 85
- Editing Function Type 85

# Operation Panel

## Keys

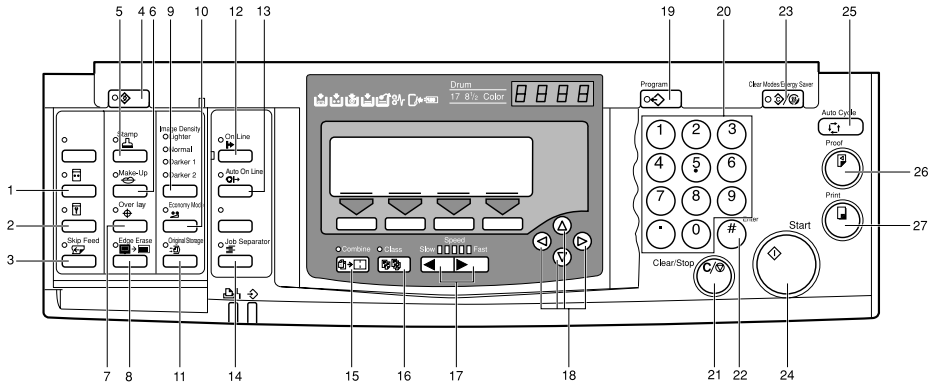

ZDZS200N

### 1. **【Quality Start】** key

See p.76 “Quality Start Mode”.

### 2. **【Security】** key

See p.75 “Security Mode”.

### 3. **【Skip Feed】** key

Press to select skip feed printing. See p.70 “Skip Feed Printing”.

### 4. **【User Tools】** key

Press to change the default settings to meet your requirements.

### 5. **【Stamp】** key

Press to select the Stamp mode. See p.108 “Date Stamp”, see p.110 “Page Stamp”, see p.113 “Stamp”.

### 6. **【Make-Up】** key

Press to select the Make-up mode. See p.94 “Make-up Printing”.

### 7. **【Overlay】** key

Press to select the Image Overlay mode. See p.105 “Image Overlay”.

### 8. **【Edge Erase】** key

Press to select Edge Erase mode. See p.41 “Edge Erase”.

### 9. **【Image Density】** key

Press to make prints darker or lighter. See p.25 “Adjusting the Image Density of Prints”.

### 10. **【Economy Mode】** key

Press to save ink. See p.50 “Economy Mode”.

### 11. **【Original Storage】** key

Press to select the Original Storage function. See p.100 “Original Storage”.

### 12. **【On Line】** key

See p.80 “On Line Printing”.

### 13. **【Auto On Line】** key

See p.80 “On Line Printing”.

### 14. **【Job Separator】** key

See p.77 “Job Separation”.

### 15. **【Combine】** key

Press to combine originals onto one print. See p.63 “Combine Originals”, see p.115 “Memory Combine”, see p.68 “Auto Combine Mode”.

## **16. [Class] key**

Press to select All Class, Auto Class, Manual Class, or Class mode. See p.52 "All Class Mode", see p.54 "Auto Class Mode", see p.57 "Manual Class Mode with One Original", see p.59 "Manual Class Mode with two or More Originals", see p.61 "Class Mode".

## **17. [◀][▶] keys (Speed keys)**

Press to adjust the printing speed. See p.25 "Adjusting the Image Density of Prints", see p.27 "Changing the Printing Speed".

## **18. [◀][▶][△][▽] keys**

Press to shift the image forward, backward, right, or left. See p.24 "Adjusting the Position of Printed Images".

Also use to highlight items you wish to select on the panel display.

## **19. [Program] key**

Press to enter or recall programs. See p.72 "Programs".

## **20. Number keys**

Press to enter the desired number of prints and data for selected modes.

## **21. [Clear/Stop] key**

Press to stop printing.

## **22. [#] key**

Use to enter data in selected modes.

## **23. [Clear Modes/Energy Saver] key**

Press to clear any previously entered job settings.

## **24. [Start] key**

Press to make a master.

## **25. [Auto Cycle] key**

Use to process the master and make prints in one operation. See p.51 "Auto Cycle".

## **26. [Proof] key**

Press to make proof prints.

## **27. [Print] key**

Press to start printing.

# Indicators

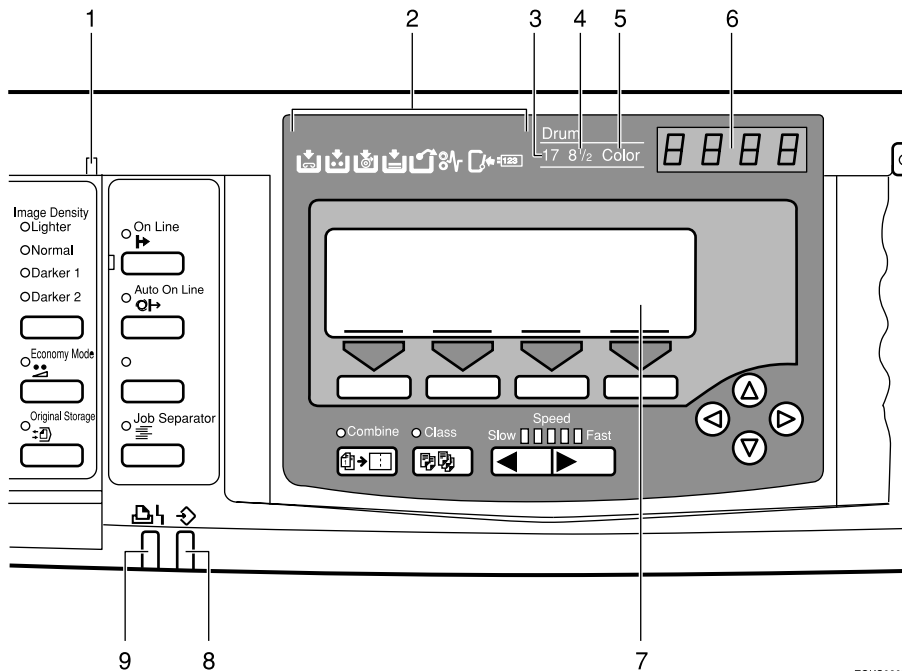

ZGKS020N

## 1. Special feature indicator

Lights to indicate that special features have been selected. To access the special features, lift up the cover on the left side of the operation panel.

## 2. Monitor indicators

These indicators light to inform you of the status of the machine. See p.167 "If Your Machine Does Not Operate as You Want".

## 3. A3/11" × 17" drum indicator

Lights when the A3, 11" × 17" drum unit is installed. See p.134 "Changing the Drum Size".

## 4. A4, 8<sup>1</sup>/<sub>2</sub>" × 11" drum indicator

Lights when the A4, 8<sup>1</sup>/<sub>2</sub>" × 11" drum unit is installed. See p.134 "Changing the Drum Size".

## 5. Color drum indicator

Lights when the color drum unit is installed. See p.130 "Color Printing Using the Optional Color Drum".

## 6. Counter

Displays the number of prints entered. While printing, it shows the number of prints remaining.

## 7. Panel display

See p.9 "Panel Display".

## 8. Data In indicator (Green)

Indicates the status of this machine:

- On: Data waiting for Master Making and printing is in the machine.
- Blinking: Data is being received, or Master Making or printing is in progress.
- Off: Master Making and printing are completed.

## 9. Error indicator (Red)

Indicates the status of this machine:

- On: An error has occurred. Master Making and printing stops.
- Off: Normal status

# Panel Display

The panel display shows the machine status, error messages, and function menus.

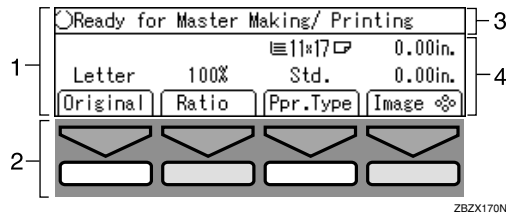

1. Items for the selected function
2. These keys correspond to the selectable items shown above them on the panel display. To select an item shown on the panel display, press the key directly below it.
3. Machine status or messages
4. Items which can be selected

## Important

- Strong impact or pressure exceeding 30N will damage the panel display.

## Note

- When you select an item on the panel display, it is highlighted (e.g. **Auto**).
- Items shown grayed-out (e.g. **OK**) cannot be selected.
- Common panel display items

[OK]	Confirms a function selection or enters a value.
[Cancel]	Cancels a function selection or entered value and returns to the previous display.
[Prev.][Next]	When there are too many items to fit on the panel display, use these keys to move between pages.
[◀][▶][△][▽][←][→]	Press to highlight items you wish to select on the panel display.
[Select]	Selects a value.
[Exit]	Returns to the previous display.

## Panel Display Layout

The basic elements used on the panel display are shown below. Understanding their meaning helps you use this machine's features quickly and easily.

### ◆ Sample display when selecting the [Original] key

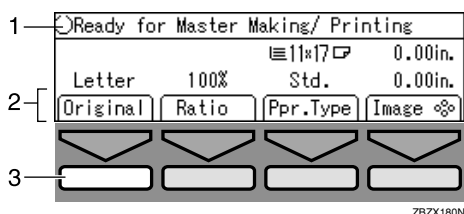

#### 1. Machine status or message

#### 2. Available functions

#### 3. Illustrations of displays in this manual show the next key to be pressed whitened

When the [Original] key is pressed, the following display is shown.

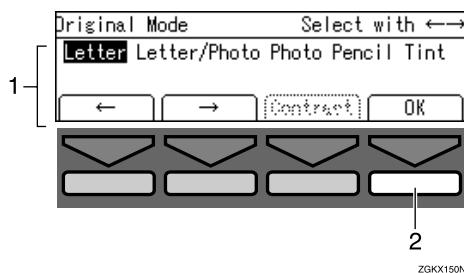

#### 1. Available functions

#### 2. Confirms the settings

# 1. Operation

## Print Paper

The following limitations apply

	Paper Size		Paper Weight
	Metric	Inch	
Paper feed tray	A3 ☐, B4 ☐, A4 ☐ ☐, B5 ☐ ☐, A5 ☐, B6 ☐, A6 ☐, Others (Vertical: 70 - 297mm, Horizontal: 148 - 432mm)	11" × 17" ☐, 8½" × 14" ☐, 8½" × 11" ☐ ☐, 5½" × 8½" ☐ ☐, Others (Vertical: 2.76" - 11.7", Horizontal: 5.83" - 17")	47.1 - 209.3g/m <sup>2</sup> , 12.5 - 55.6 lb

Non-recommended paper:

- Roughly cut paper
- Paper of different thickness in the same stack
- Envelopes heavier than 85g/m<sup>2</sup>, 22 lb.
- Folded, curled, creased, or damaged paper
- Torn paper
- Slippery paper
- Rough paper
- Paper with any kind of coating (such as carbon)
- Short grain paper
- Thin paper that has low stiffness
- Paper that may create a lot of dust
- Grained paper with the direction of the grain running opposite to the feed direction
- Certain types of long thin envelopes.  
E.g. international mail envelopes

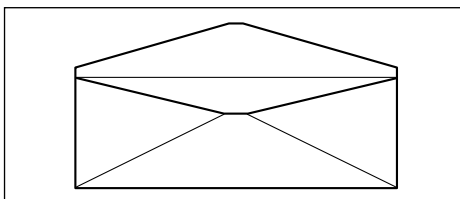

ZFXX040N

- The following types of envelopes

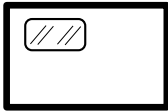
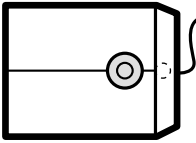
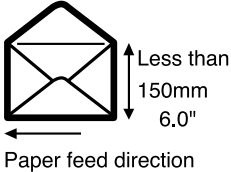
Envelopes with glue or gum	Envelopes with windows	Envelopes with round tags	Open envelopes
			

**Note**

- If you print on rough grained paper, the copy image might be blurred.
- You can use A3 (297 × 420mm) or 11" × 17" originals or printing paper. When you want to print the entire image of an A3, 11" × 17" original, select Reduce mode because the maximum print areas are as follows:
  - Metric version: 290 × 409mm, 11.4" × 16.1"
  - Inch version: 290 × 419mm, 11.4" × 16.4"
- When you use A3, 11" × 17" and 209.3g/m<sup>2</sup>, 55.6 lb paper, slow the printing speed down to setting 1, 2, or 3.

**Important**

- Correct curls in the paper before placing it in the machine. When you cannot correct the paper curl, stack the paper with the curl face down or face up as shown in the illustration. If the paper is curled, it might wrap around the drum or stains might appear.

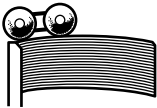
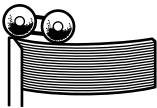
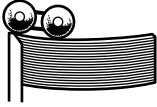
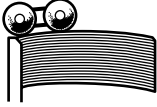
	Right	Wrong
Thin Paper		
Thick Paper		

TPEY990E



# Originals

The machine can detect the following original sizes placed on the exposure glass.

Metric version	A3☐, B4☐, A4☐☐, B5☐☐
Inch version	11" × 17"☐, 8 <sup>1</sup> / <sub>2</sub> " × 14"☐, 8 <sup>1</sup> / <sub>2</sub> " × 11"☐☐

## 🔍 Reference

For the original sizes placed in the document feeder can be detected, see p.125 "Optional Document Feeder".

If the machine cannot detect the original sizes properly, select the area to copy with the **[Edge Erase]** key. See p.41 "Edge Erase". The machine may not detect the original size properly when:

- Originals contain index tabs.
- Originals are OHP transparencies or are translucent.
- Originals are dark.
- Originals contain solid images.
- Originals are of sizes other than those listed above.

If you do not lift the exposure glass cover more than 30cm, 12" when you place another original, the machine might not detect the next original size correctly.

The maximum original size you can place on the exposure glass is 304.8 × 432mm, 12" × 17".

If you use originals that have bold letters or solid images at the leading edges, you might get prints with dirty edges. In this case, place the original face down with the widest margin toward the paper delivery tray or raise the printing speed.

Make sure any correction fluid or ink is completely dry before placing originals on the exposure glass. Not taking this precaution could mark the exposure glass and cause marks to be printed.

In most situations, place originals as shown below.

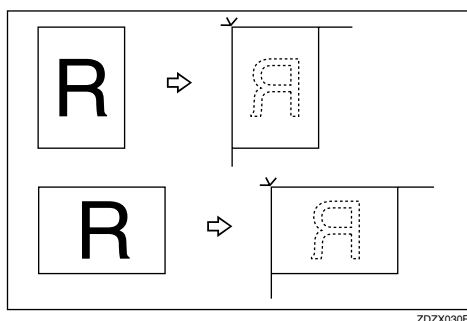

ZDZX030E

When the original is placed in a direction that differs from the print paper, the machine automatically rotates the original image by 90° to match the print paper direction.

The first 8mm, 0.32", of the leading edge and the last 2mm, 0.08", of the trailing edge cannot be printed. Make sure the leading edge margin is at least 8mm, 0.32", and the trailing edge margin is at least 2mm, 0.08".

1

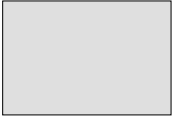
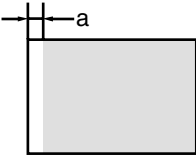
Original	Print
	

$a = 8\text{mm}, 0.32''$

# Printing Preparations

## Loading Paper

- 1 Carefully open the paper feed tray.

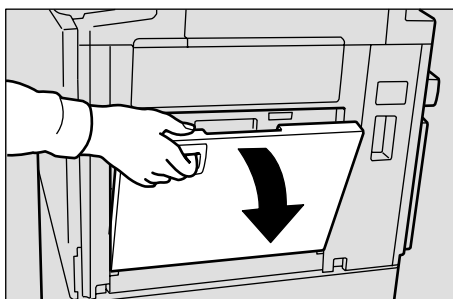

ZDCY130E

- 2 Lift the paper feed side plates.

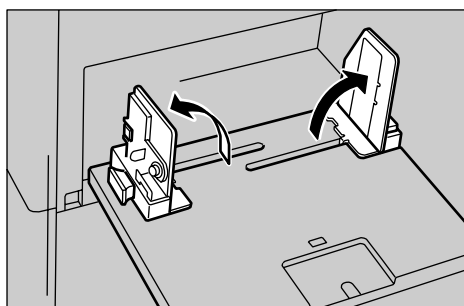

ZFX010E

- 3 Grasp the paper feed side plates knob and adjust the paper feed side plates to match the paper size.

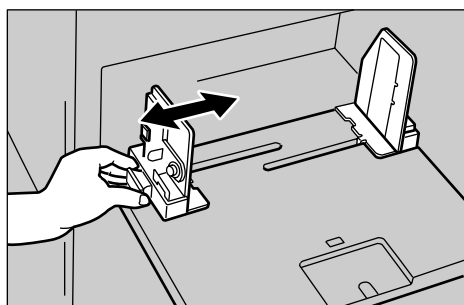

TPEY030E

- 4 Place the paper on the paper feed tray.

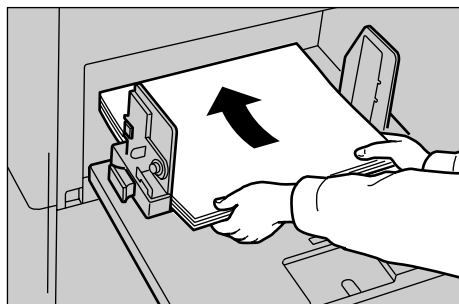

TPEY040E

### Note

- ❑ Correct the paper curl before loading the paper. If you cannot do so, stack the paper with the curl face down.

### Reference

See p.11 "Print Paper".

- 5 Make sure that the paper feed side plates touch both sides of the paper lightly.

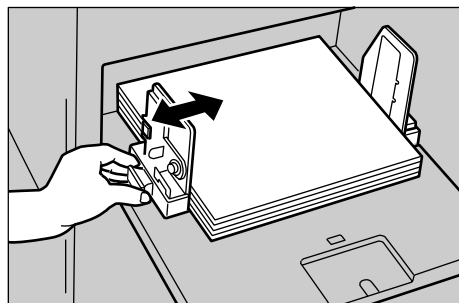

TPEY050E

### Note

- ❑ Make sure that the paper size and direction in the panel display correspond with the actual paper size and direction set on the paper feed tray.

## Setting Up The Paper Delivery Tray

1

- 1 Raise the paper delivery tray slightly, and then gently lower it with your hand.

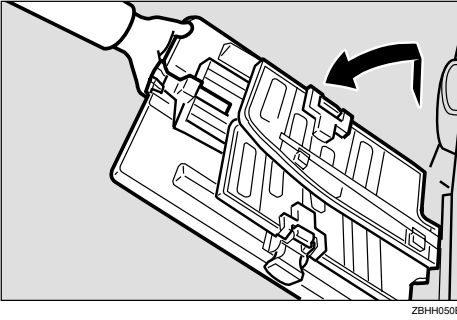

ZBHH050E

- 2 Raise each paper delivery side plate, and then grasp the side plate knobs and move the paper delivery side plates to match the print paper size.

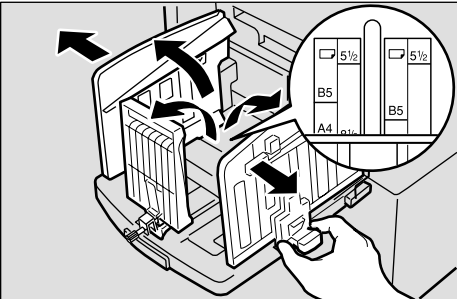

ZDZH180E

**Note**

- The inside of the plates should correspond to the paper size.

When you use thick paper (128 g/m<sup>2</sup> to 209.3 g/m<sup>2</sup>, 34 lb to 55.6 lb)

- 1 Adjust the side plates to match the paper size scale on the main frame side.

When you use standard paper (47.1 g/m<sup>2</sup> to 105 g/m<sup>2</sup>, 12.5 lb to 28 lb)

- 1 Adjust the side plates to match the paper size scale on the end plate side.

- 3 Lower or lift the paper alignment wings by turning the left and right knobs.

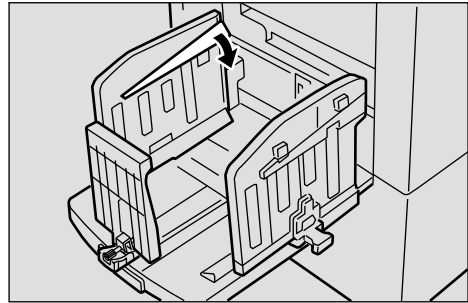

ZDZH190E

**Note**

- When the guides are up, you might not be able to load the unit to full capacity (1,000 sheets) depending on the paper you are using.
- Lift the paper alignment wings if B5 prints are curled.

When you use 81.4 g/m<sup>2</sup>, 21.6 lb or thicker paper

- 1 Lower the paper alignment wings.



When you use 81.4 g/m<sup>2</sup>, 21.6 lb or thinner and B5 or smaller paper

- 1 Lower the paper alignment wings.

When you use 81.4 g/m<sup>2</sup>, 21.6 lb or thinner and A4, 8 1/2 × 11" or larger paper

- 1 Lift the paper alignment wings.

---

When you use A4, 8 1/2" × 11"    
paper

---

- 1 Swing out the guides as shown in the illustration.

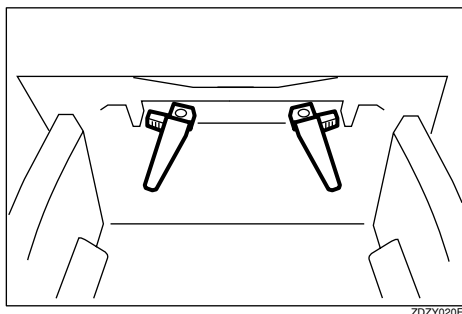

- 4 Turn on the main switch.

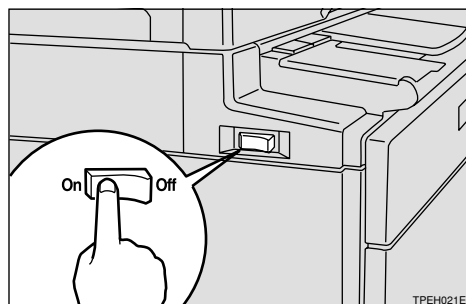

 **Note**

- You can have the machine display how much ink and master are left when you switch it on. See “User Tools—Ink/Master Left” on p.144 “4. Mode Setting”.

# Entering a User Code to Use the Machine

1

If user codes are turned on, operators must enter their user code before they can use the machine. The machine keeps count of the number of copies made under each user code.

**Note**

- If you want to use this feature, you must turn it on and register the user codes with the user tools. You can register up to 20 user codes. See “Set User Code” and “Reg. User Code” on p.150 “6. Administrator Mode”.
- When user codes are turned on, the machine will prompt you for your user code when you turn on the main switch or after the machine has been reset.

**1** Enter your 4–digit user code with the number keys.

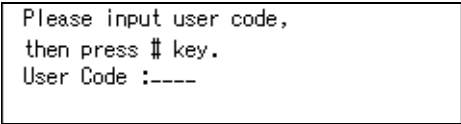

**Note**

- User codes are not displayed on the panel display.
- To change the number entered, press the **[Clear/Stop]** key and enter the new number.

**2** Press the **[#]** key.

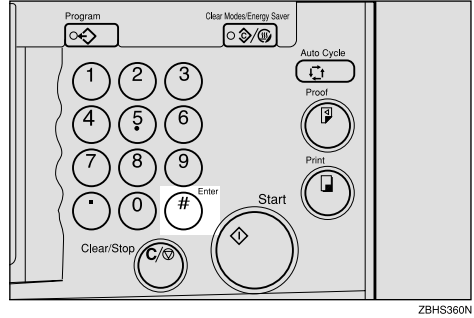

ZBHS360N

**3** Make your prints.

**4** To prevent others from making prints with your user code, hold down the **[Clear Modes/Energy Saver]** key, and then press the **[Clear/Stop]** key.

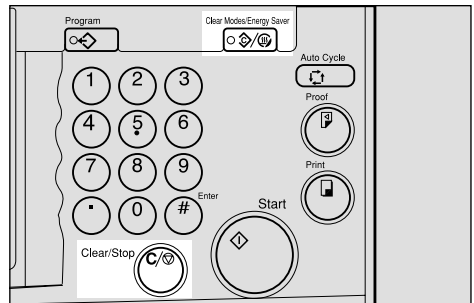

ZBHS370N

# Standard Printing

- 1** Make sure that the machine is ready for printing.

○Ready for Master Making/ Printing			
	≡11×17□		0.00in.
Letter	100%	Std.	0.00in.
Original	Ratio	Ppr.Type	Image ☼

- 2** If user codes are turned on, enter your user code with the number keys, and then press the **[#]** key.

 **Reference**

See p.18 “Entering a User Code to Use the Machine”.

- 3** Make sure that there are no previous settings remaining.

 **Note**

- To clear any previous settings, press the **[Clear Modes/Energy Saver]** key.

- 4** Lift the exposure glass cover.

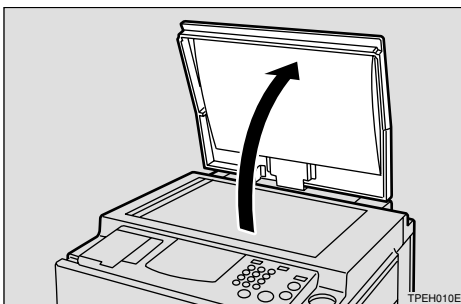

 **Note**

- Be sure to lift the exposure glass cover more than 30cm, 12”.

- 5** Place the original face down on the exposure glass. The original should be aligned with the reference mark and the left corner scale.

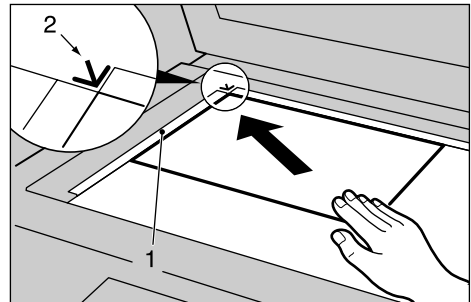

1. Left corner scale
2. Reference mark

- 6** Lower the exposure glass cover.

- 7** Make your desired settings.

- 8** Press the **[Start]** key.

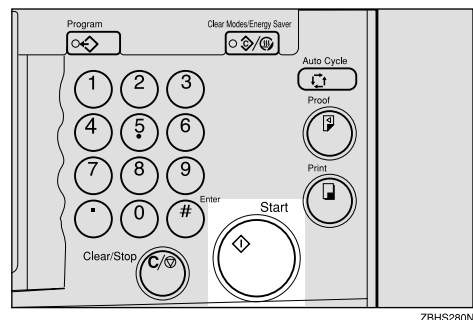

A trial print is delivered to the paper delivery tray.

- 9** Press the **[Proof]** key and check the image density and the image position on the proof print.

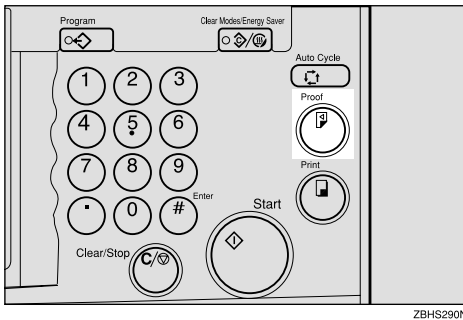

**Note**

- If the image position is not correct, adjust it using the **[Image ⌘]** key. See p.24 “Adjusting the Position of Printed Images”.
- If the image density is slightly dark or light, adjust the image density using the **[◀][▶]** keys. See p.25 “Adjusting the Image Density of Prints”.

- 10** Enter the number of prints required with the number keys.

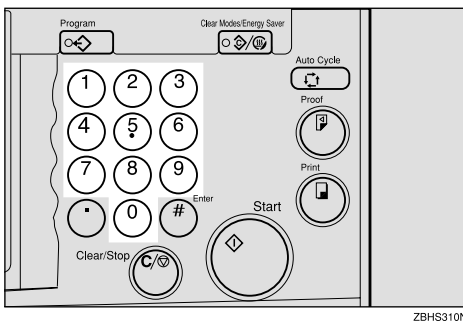

**Note**

- To change the number entered, press the **[Clear/Stop]** key and enter the new number.

- 11** Press the **[Print]** key.

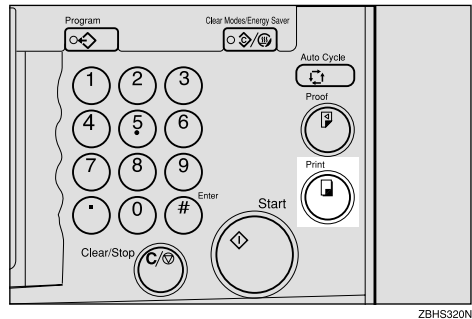

**Note**

- To stop the machine during a multi-print run, press the **[Clear/Stop]** key.
- To return the machine to the initial condition after printing, press the **[Clear Modes/Energy Saver]** key.

## Removing Prints

- 1** Pull the front paper delivery side plate down towards you to open.

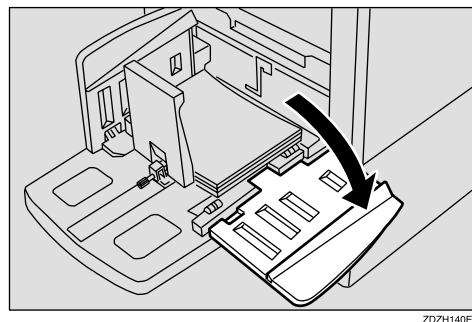

**Note**

- You cannot open the rear paper delivery side plate.



- 2** Remove the prints from the paper delivery tray and close the paper delivery side plate.

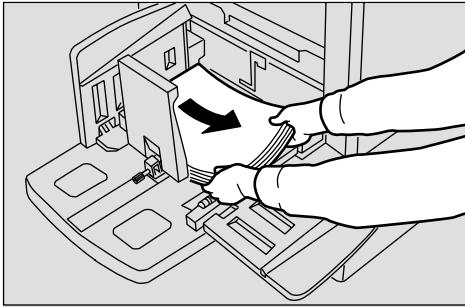

ZDZH150E

# Energy Saver Mode

1

If you do not operate the machine for a certain period, the display disappears and the machine enters Energy Saver mode to reduce energy consumption.

## Note

- You can change the time the machine waits before Energy Saver mode starts. See “Energy Saving” on p.141 “1. System”.
- The machine will not automatically enter Energy Saver mode in such cases as follows:
  - If there is no ink
  - If originals or paper are jammed
  - If the machine is making master or printing
  - If the machine is printing the second page of a combined print job
  - If the machine is loading original images in memory
  - If there is no paper
  - If there is no master
  - If the master eject unit is full
  - If originals are left on the document feeder
  - If the “cover open” message is displayed
  - If the settings have been reset to their defaults
  - If there are prints in the sorter's paper delivery tray
  - If the User Code entry screen is displayed

# Auto Reset

If you do not operate the machine for a certain period after printing, the machine will return to the initial condition. This function is called "Auto Reset".

## Note

- You can change the time the machine waits before Auto Reset starts. See "Auto Reset" on p.141 "1. System".
- The machine will not enter Auto Reset in such cases as follows:
  - If there is no ink
  - If originals or paper are jammed
  - If the machine is making master or printing
  - If the machine is printing the second page of a combined print job
  - If the machine is loading original images in memory
  - If there is no paper
  - If there is no master
  - If the master eject unit is full
  - If originals are left on the document feeder
  - If the "cover open" message is displayed
  - If the settings have been reset to their defaults
  - If you select "Off" for "Auto Reset" with the user tools

# Adjusting the Position of Printed Images

1

Use the following procedure to adjust the position of print images as required.

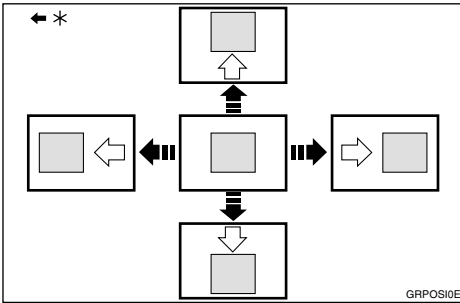

\* Paper feed direction

**Limitation**

- ❑ For 308 mm, 12.2"-width paper, you can only adjust the position of the print image 5 mm, 0.2" up or down.

**Note**

- ❑ When the main switch is turned off, the position returns to the default.

**1** Press the [Image ⚙️] key.

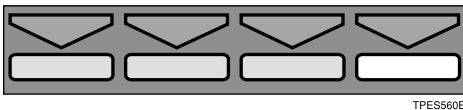

**Note**

- ❑ You can skip step 1 and adjust the image position directly by pressing the [◀], [▶], [▲], and [▼] keys.

**2** Adjust image position using the [◀], [▶], [▲], and [▼] keys.

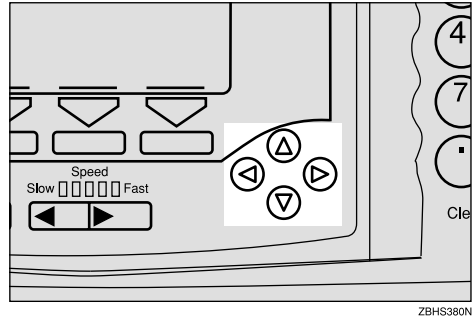

**Note**

- ❑ When you shift the image forward, leave a 10mm, 0.4" margin at the leading edge. If there is no margin, paper might wrap around the drum and cause a misfeed.
- ❑ The [◀] and [▶] keys shift the image up to 15mm, 0.6" each way in 0.5mm, 0.02" steps.
- ❑ The [▲] and [▼] keys shift the image up to 10mm, 0.4" each way in 0.5mm, 0.02" steps.

**3** Press the [OK] key.

**4** Press the [Proof] key to check the image position.

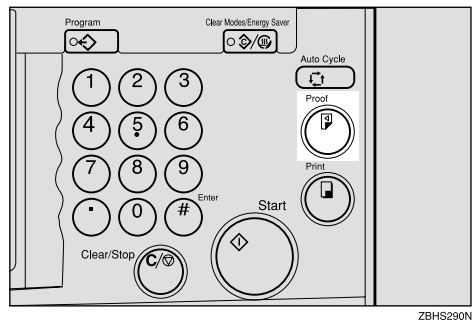

# Adjusting the Image Density of Prints

There are two ways to adjust the image density of prints:

- ❖ **Before making a master**  
Use the **[Image Density]** key.
- ❖ **After making a master**  
Use the **[◀][▶]** (Speed) keys.

## Before Making a Master

- 1** Press the **[Image Density]** key to adjust the image density.

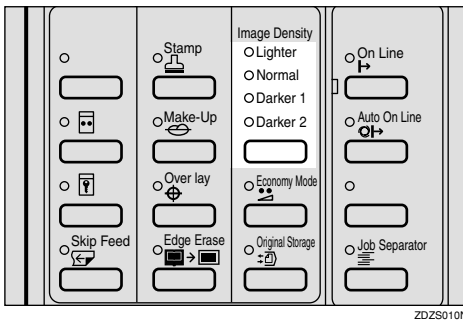

- 2** Press the **[Start]** key.

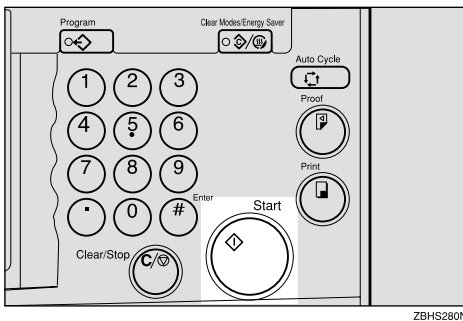

## After Making a Master

- 1** To increase the image density, press the **[◀]** key. To reduce the image density, press the **[▶]** key.

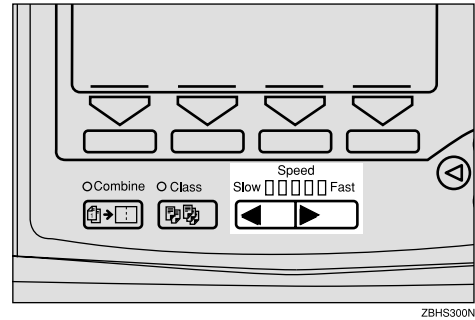

### Note

- ❑ The faster the printing speed becomes, the lighter the printing density is. If you want darker prints, decrease the printing speed.

# Tint Mode

Use this function to make halftone prints.

1

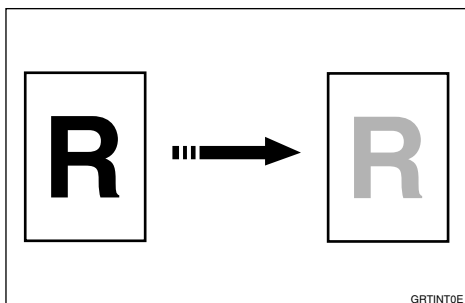

**1** Press the [Original] key.

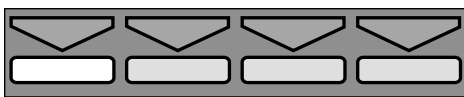

**2** Select the [Tint] with the [←] [→] or [◀] [▶] keys.

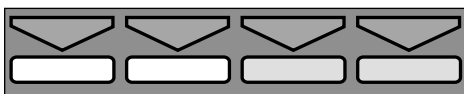
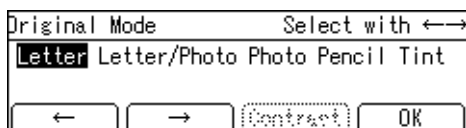

**3** Press the [Start] key.

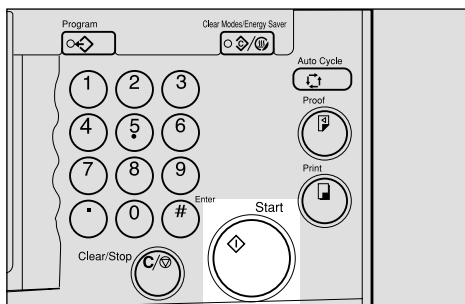

# Changing the Printing Speed

Use the [◀] or [▶] key to adjust the printing speed. The relationship between printing speed and print quality depends on the type of paper you use.

- 1 Press the [▶] key to increase the speed and press the [◀] key to reduce the speed.

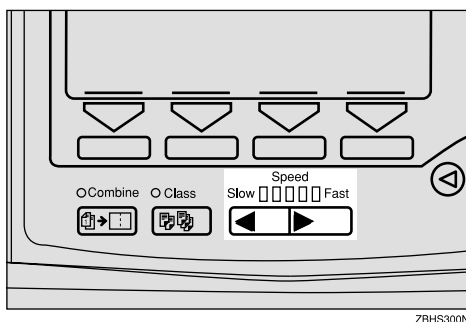

## Note

- ❑ The following speeds are available:
  - Setting 1:  
60 sheets/minute
  - Setting 2:  
75 sheets/minute
  - Setting 3 (default):  
90 sheets/minute
  - Setting 4:  
105 sheets/minute
  - Setting 5:  
120 sheets/minute
- ❑ The faster the printing speed becomes, the lighter the printing density is, and vice versa.
- ❑ When the machine is used in low temperature conditions, the image density might decrease. In this case, slow the printing speed down to setting 1 or 2.

# Stopping a Multi-print Run

1

## Stopping a Multi-print Run to Print Another Original

**1** Press the **[Clear/Stop]** key.

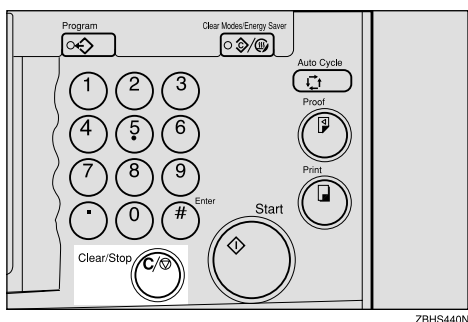

**2** Set the original.

**3** Enter the number of prints and press the **[Start]** key.

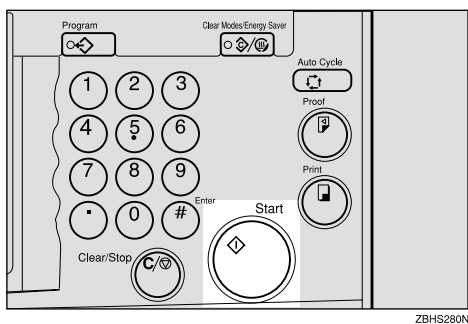

## Changing the Number of Prints Entered and Checking Completed Prints

**1** Press the **[Clear/Stop]** key.

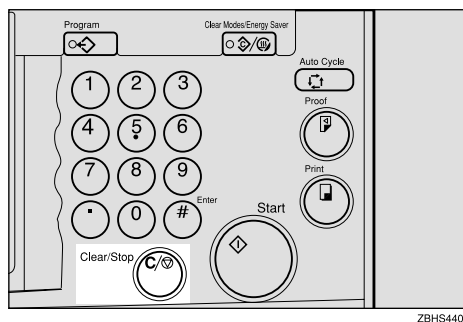

**2** Change the number of prints or check the completed prints.

**Note**

- To change the number of prints, press the **[Clear/Stop]** key, and then re-enter the number of prints with the number keys.

**3** Press the **[Print]** key.

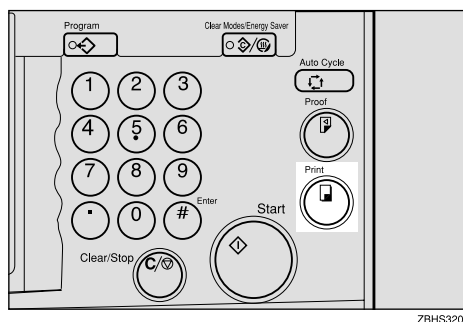



# Reducing and Enlarging Using Preset Ratios

Use this function to have originals reduced or enlarged by a preset ratio. A total of 7 ratios are available (3 enlargement ratios, 4 reduction ratios).

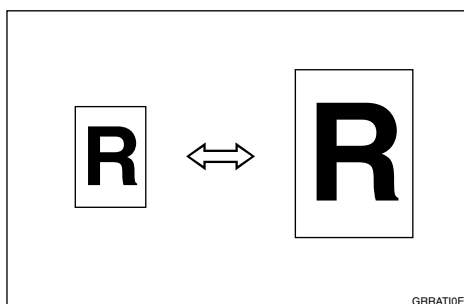

## Note

- The leading edge of the print image does not shift when a print image is made with this function.

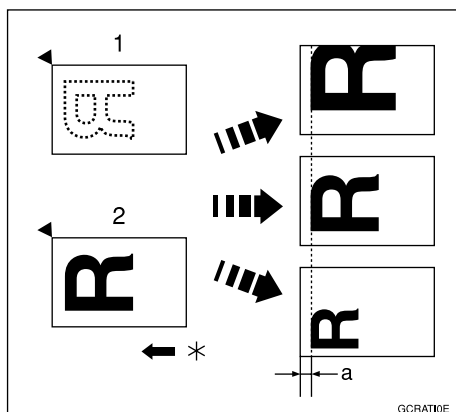

- Place on the exposure glass
- Place in the optional document feeder

\* Paper feed direction

a = 8mm, 0.32"

- You can select a ratio regardless of the size of an original or printing paper. With some ratios, parts of the image might not be printed or margins will appear on prints.
- You can change the preset reproduction ratios with the user tools. See "Reproduction Ratio" on p.154 "3-4 Reproduction Ratio".
- Prints can be reduced or enlarged as follows.

## ◆ Metric version

Ratio (%)	Original → Print paper size
141	A4 → A3, A5 → A4, B5 → B4
122	A4 → B4, A5 → B5
115	B4 → A3, B5 → A4
93	—
87	A3 → B4, A4 → B5
82	B4 → A4, B5 → A5
71	A3 → A4, A4 → A5, B4 → B5

## ◆ Inch version

Ratio (%)	Original → Print paper size
155	5 1/2" × 8 1/2" → 8 1/2" × 14"
129	8 1/2" × 11" → 11" × 17", 5 1/2" × 8 1/2" → 8 1/2" × 11"
121	8 1/2" × 14" → 11" × 17"
93	—
77	8 1/2" × 14" → 8 1/2" × 11"
74	11" × 15" → 8 1/2" × 11"
65	11" × 17" → 8 1/2" × 11", 8 1/2" × 11" → 5 1/2" × 8 1/2"

**1** Press the [Ratio] key.

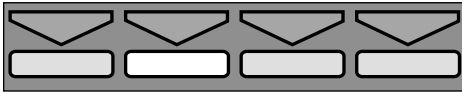

TPES570E

**2** Select the desired ratio with the [←] [→] or [◀] [▶] keys.

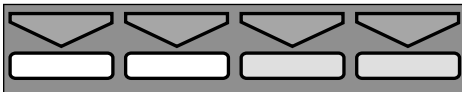
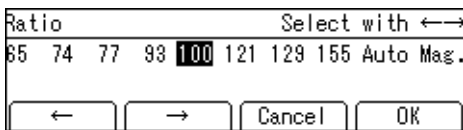

TPES530E

**3** Press the [OK] key.

**4** Make sure that the original and the print paper are the correct size.

**5** Place your original on the exposure glass or in the optional document feeder.

**6** Press the [Start] key.

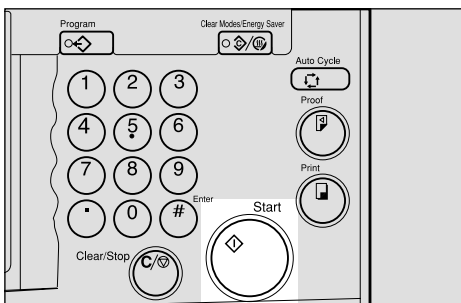

ZBHS280N

**7** Check the image position on the trial or proof print.

**Note**

- If the image position is not correct, adjust it using the [Image] key. See p.24 "Adjusting the Position of Printed Images".

**8** Make your prints.

# Auto Magnification

Use this function to have the machine choose an appropriate enlargement or reduction ratio based on the size of your original and the paper size you select.

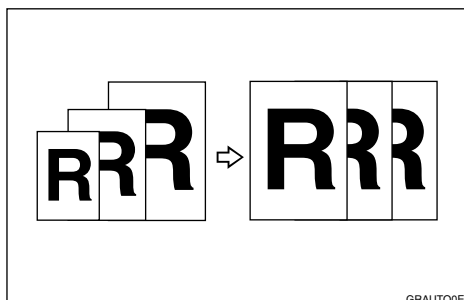

## Note

- The range of ratios which the machine can select depends on where you place the original:
  - On the exposure glass: 50 – 200%
- The table below shows the reproduction ratios that can be selected for various combinations of original and paper size.

### ◆ Metric version

Original Paper	A3	B4	A4	A4	B5	B5	A5 <sup>*2</sup>	A5 <sup>*2</sup>
A3	100%	115%	141%	--	163%	--	200%	--
B4	87%	100%	122%	--	141%	--	173%	--
A4	71%	82%	100%	100% <sup>*1</sup>	115%	115% <sup>*1</sup>	141%	141% <sup>*1</sup>
A4	71% <sup>*1</sup>	82% <sup>*1</sup>	100% <sup>*1</sup>	100%	115% <sup>*1</sup>	115%	141% <sup>*1</sup>	141%
B5	61%	71%	87%	87% <sup>*1</sup>	100%	100% <sup>*1</sup>	122%	122% <sup>*1</sup>
B5	61% <sup>*1</sup>	71% <sup>*1</sup>	87% <sup>*1</sup>	87%	100% <sup>*1</sup>	100%	122% <sup>*1</sup>	122%
A5	50%	50%	71%	71% <sup>*1</sup>	82%	82% <sup>*1</sup>	100%	100% <sup>*1</sup>
B6	--	50%	61%	61% <sup>*1</sup>	71%	71% <sup>*1</sup>	87%	87% <sup>*1</sup>

<sup>\*1</sup> The machine automatically rotates the original image by 90° to match the paper direction and selects an appropriate reproduction ratio. See p.82 "Image Rotation".

<sup>\*2</sup> Place these originals in the optional document feeder.

◆ Inch version

Original Paper	11" × 17" ☐	8 1/2" × 14" ☐	8 1/2" × 11" ☐	8 1/2" × 11" ☐	8 1/2" × 5 1/2" ☐ *2	8 1/2" × 5 1/2" ☐ *2
11" × 17"☐	100%	121%	129%	--	200%	--
8 1/2" × 14" ☐	77%	100%	--	--	155%	--
8 1/2" × 11" ☐	65%	77%	100%	100% *1	129%	129% *1
8 1/2" × 11" ☐	65% *1	77% *1	100% *1	100%	129% *1	129%
8 1/2" × 5 1/2" ☐	50%	61%	65%	65% *1	100%	100% *1

\*1 The machine automatically rotates the original image by 90° to match the paper direction and selects an appropriate reproduction ratio. See p.82 "Image Rotation".

\*2 Place these originals in the optional document feeder.

☐ Depending on the original type, a suitable reproduction ratio might not be able to be selected. See p.13 "Originals" and see p.125 "Originals".

**1** Place your original on the exposure glass or in the optional document feeder.

**2** Press the [Ratio] key.

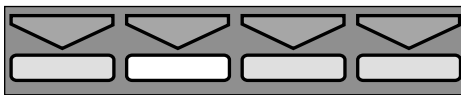
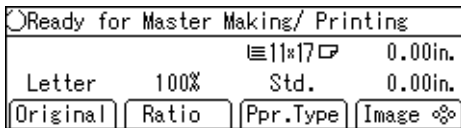

TPES570E

**3** Select [Auto] with the [→] or [▷] key.

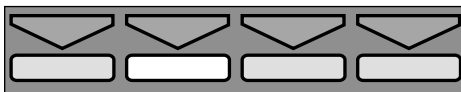
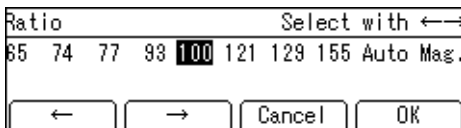

TPES570E

**4** Press the [OK] key.

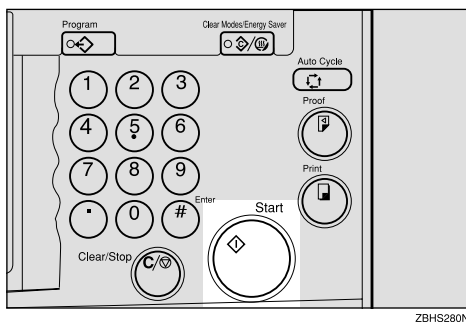
**5** Press the **[Start]** key.**6** Check the image position on the trial or proof print.**Note**

- If the image position is not correct, adjust it using the **[Image ⚙️]** keys. See p.24 “Adjusting the Position of Printed Images”.

**7** Make your prints.

# Zoom

1

Use this function to fine-tune the reproduction ratio in increments of 1%.

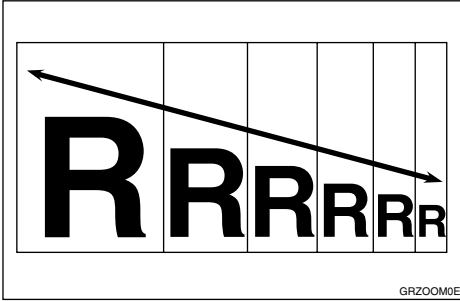

### Note

- ❑ The range of ratios you can select depends on where you place the original:
  - On the exposure glass: 50–200%

**1** Press the [Ratio] key.

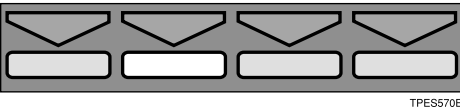

**2** Select [Mag.] with the [→] or [▷] key.

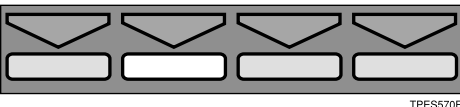
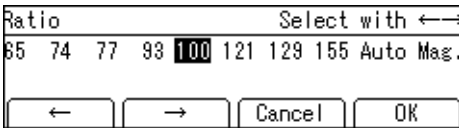

### Note

- ❑ To select a custom ratio, select the closest ratio with the [←] [→] or [◀] [▶] keys. Then press the [▲] or [▼] key and go to step 6.

**3** Press the [OK] key.

**4** Make sure that [Zoom] is selected.

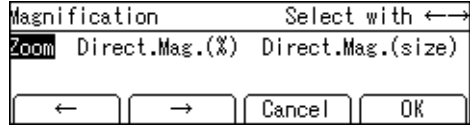

**5** Press the [OK] key.

**6** Select the desired reproduction ratio in one of the following ways:

### Note

- ❑ To change the value entered, press the [Clear/Stop] key and enter the new value.

Using the [←] [→] or [◀] [▶] keys

**1** Adjust the ratio with the [←] [→] or [◀] [▶] keys.

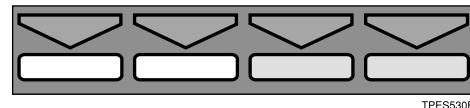
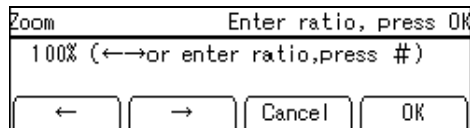

## Using the number keys

- 1 Enter the ratio with the number keys.

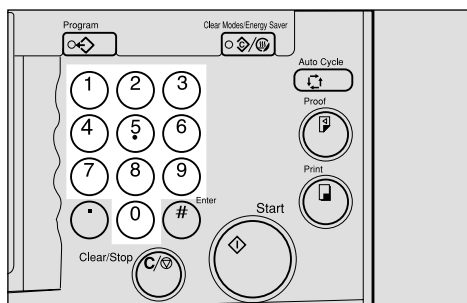

ZBHS310N

- 2 Press the [#] key.

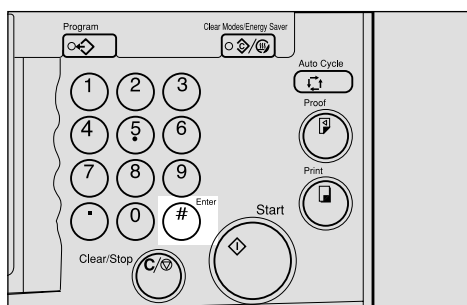

ZBHS360N

- 7 Press the [OK] key.
- 8 Make sure that the original and the print paper are the correct size.
- 9 Place your original on the exposure glass or in the optional document feeder.
- 10 Press the [Start] key.

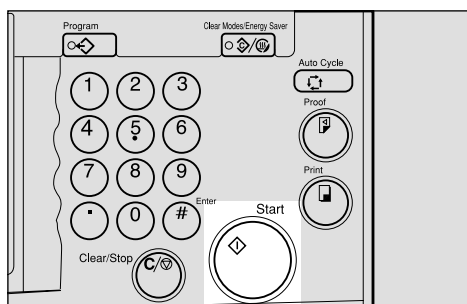

ZBHS280N

- 11 Check the image position on the trial or proof print.

### Note

- If the image position is not correct, adjust it using the [Image 

- 12 Make your prints.

1

# Directional Magnification (%)

1

Use this function to choose different reproduction ratios for the horizontal and vertical directions. The result is a squeezing or stretching effect.

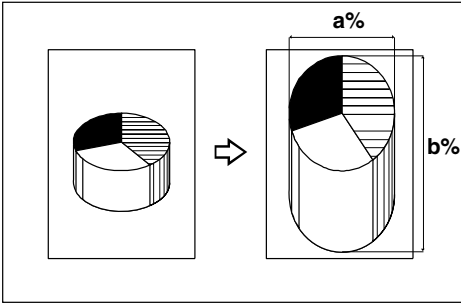

CP2P01EE

**Note**

- The range of ratios you can select depends on where you place the original:
  - On the exposure glass: 50 – 200%

**1** Press the [Ratio] key.



TPES570E

**2** Select [Mag.] with the [→] or [▷] key.

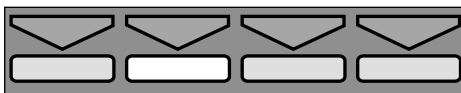
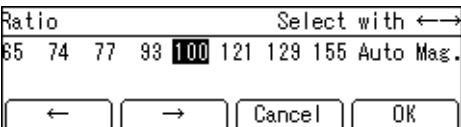

TPES570E

**3** Press the [OK] key.

**4** Select [Direct.Mag.(%)] with the [→] or [▷] key.

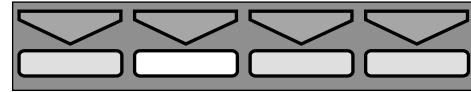
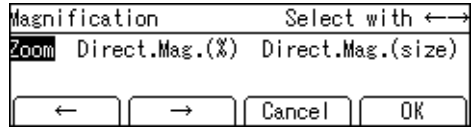

TPES570E

**5** Press the [OK] key.

**6** Enter the vertical and horizontal ratio.

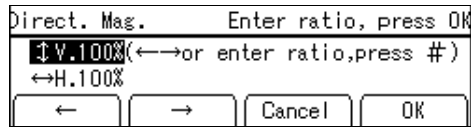

**Note**

- To change the value entered, press the [Clear/Stop] key and enter the new value.

Adjusting ratios with the [←] [→] or [◀] [▶] keys

- 1** Adjust the vertical ratio with the [←] [→] or [◀] [▶] keys.
- 2** Press the [▽] key.
- 3** Adjust the horizontal ratio with the [←] [→] or [◀] [▶] keys.



## Entering ratios with the number keys

- 1 Enter the vertical ratio with the number keys.
- 2 Press the **[#]** key.
- 3 Enter the horizontal ratio with the number keys.
- 4 Press the **[#]** key.
- 7 Press the **[OK]** key.
- 8 Make sure that the original and the print paper are the correct size.
- 9 Place your original on the exposure glass or in the optional document feeder.
- 10 Press the **[Start]** key.

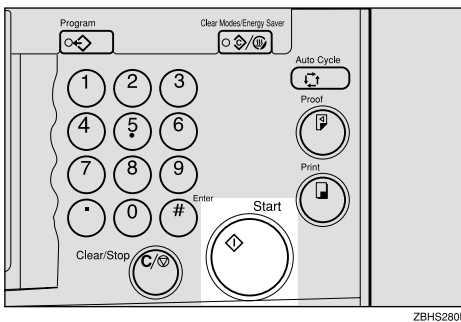

- 11 Check the image position on the trial or proof print.

### Note

- If the image position is not correct, adjust it using the **[Image ** key. See p.24 "Adjusting the Position of Printed Images".

- 12 Make your prints.

# Directional Magnification (Size)

1

Use this function to have the machine select suitable reproduction ratios based upon the dimensions of the print you require and the size of the original you specify.

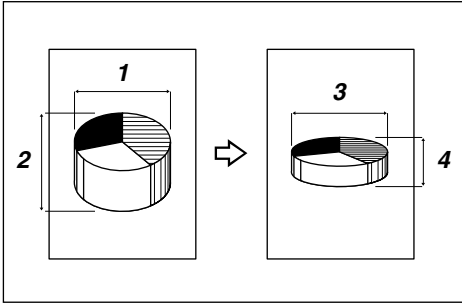

CP2M01EE

1. Horizontal original size
2. Vertical original size
3. Horizontal print size
4. Vertical print size

**Note**

You can enter sizes within the following ranges.

Metric version	1 - 999mm (in 1mm steps)
Inch version	0.1" - 99.9" (in 0.1" steps)

- The range of ratios which the machine can select depends on where you place the original:
  - On the exposure glass: 50-200%
- If the calculated ratio is over the maximum or under the minimum ratio, it is corrected within the range of ratios automatically.

**1** Press the [Ratio] key.

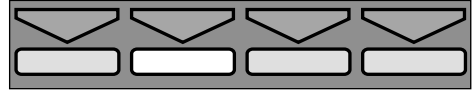

TPES570E

**2** Select [Mag.] with the [→] or [▷] key.

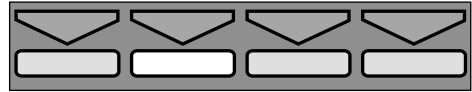
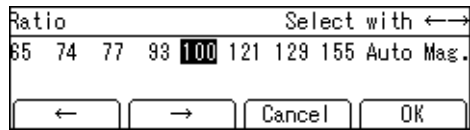

TPES570E

**3** Press the [OK] key.

**4** Select [Direct.Mag.(Size)] with the [→] or [▷] key.

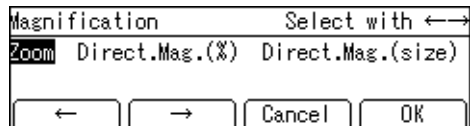

TPES570E

**5** Press the [OK] key.

- 6** Enter the vertical original size with the number keys and press the **[#]** key.

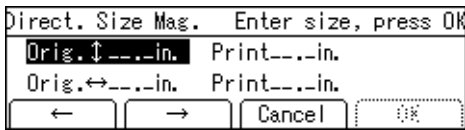

**Note**

- To change the value entered, press the **[Clear/Stop]** key and enter the new value.
- Up to 999mm, 99.9" can be entered.

- 7** Enter the vertical print size with the number keys, and then press the **[#]** key.

- 8** Enter the horizontal original size with the number keys, and then press the **[#]** key.

- 9** Enter the horizontal print size with the number keys.

- 10** Press the **[OK]** key.

The machine will select appropriate reproduction ratios for the vertical and horizontal directions.

- 11** Make sure that the original and the print paper are the correct size.

- 12** Place your original on the exposure glass or in the optional document feeder.

- 13** Press the **[Start]** key.

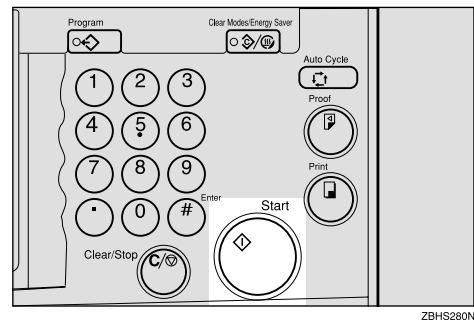

- 14** Check the image position on the trial or proof print.

**Note**

- If the image position is not correct, adjust it using the **[Image ⚙]** key. See p.24 "Adjusting the Position of Printed Images".

- 15** Make your prints.

## Erasing Center and Edge Margins

1

When printing from thick books, or similar originals, the binding margin at the center and the edges might appear on prints. To prevent this, perform the following steps.

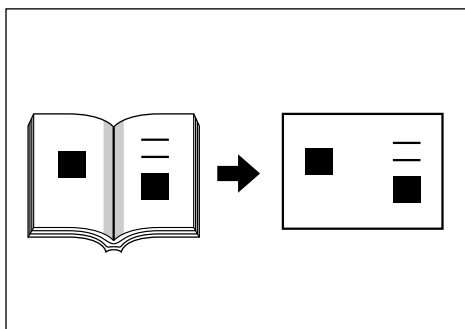

GBCER0E

### Important

- Be sure to keep the platen cover at an angle of at least 25 degrees with the exposure glass.
- If you do not press hard on the book while it is scanned, the margin at the center might not be erased completely.

### Note

- If your originals have solid images at the edges, the machine might recognize the solid images as shadows and not copy them. In this case, use Edge Erase mode so that only the shadows are not copied. See p.41 "Edge Erase".

- 1** Set the book on the exposure glass.

- 2** Keep the exposure glass cover at an angle of at least 25 degrees with the exposure glass.

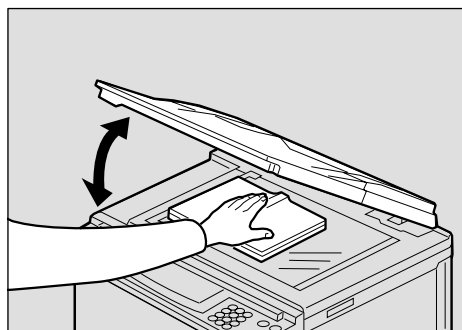

ZADH240E

- 3** Press the **[Start]** key.

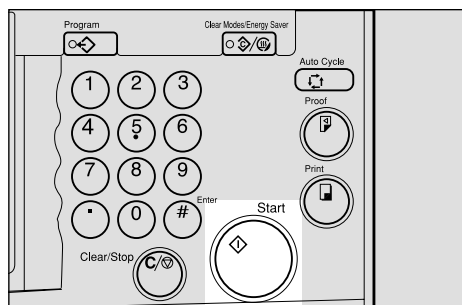

ZBHS280N

### Note

- Press hard on the book with your hand while it is scanned.

- 4** Check the image position on the trial or proof print.

### Note

- If the image position is not correct, adjust it using the **[Image ⚙️]** key. See p.24 "Adjusting the Position of Printed Images".

- 5** Make your prints.

# Edge Erase

This function erases all four margins of the original image.

## ◆ Using Edge Erase mode

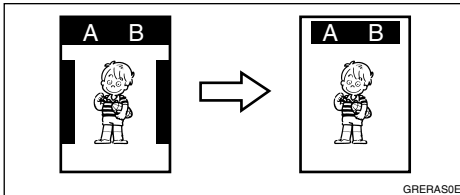

## ◆ When not using Edge Erase mode

When printing from thick books, or similar originals, the binding margin at the center and the edges might appear on prints. The machine erases these margins automatically. If you do not use Edge Erase mode using the following kind of originals, the images to be printed might be also erased.

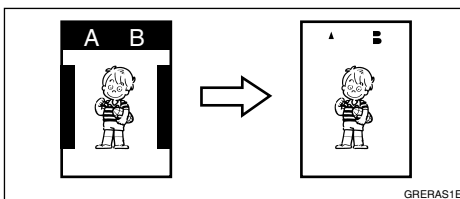

## 📌 Note

- ❑ You can adjust the size of the margins with the user tools. The default is 2mm, 0.1". See p.155 "3-11 Margin Erase Area".

## 1 Press the [Edge Erase] key.

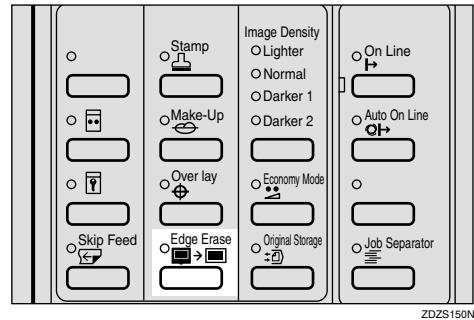

## 2 Select the size and direction of the original with the [←] [→] or [◀] [▶] keys.

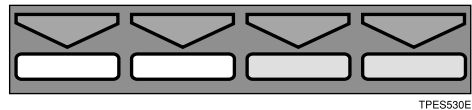
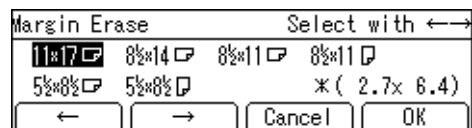

## 3 Press the [OK] key.

## 4 Place your original on the exposure glass or in the optional document feeder.

## 5 Press the [Start] key.

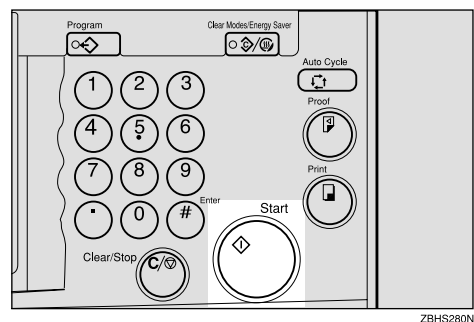

**6** Check the image position on the trial or proof print.

 **Note**

- If the image position is not correct, adjust it using the **[Image ⌘]** key. See p.24 “Adjusting the Position of Printed Images”.

**7** Make your prints.

# Printing onto Various Kinds of Paper

Before printing onto thick paper, thin paper, envelopes or special kinds of paper loaded in the paper feed tray, you must select the paper type.

## Printing onto Thick Paper

If you wish to print onto thick (128 to 209.3g/m<sup>2</sup>, 34 to 55.6 lb or heavier) paper, perform the following steps.

- 1 Press the [Ppr.Type] key.

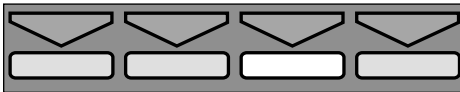

TPES520E

- 2 Select [Thick] with the [→] or [▷] key.

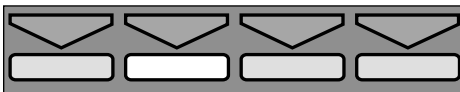
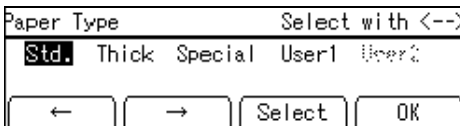

TPES570E

- 3 Press the [OK] key.

## Printing onto Standard Paper

If you wish to print onto standard (47.1 to 105g/m<sup>2</sup>, 12.5 to 28 lb) paper, perform the following steps.

- 1 Press the [Ppr.Type] key.

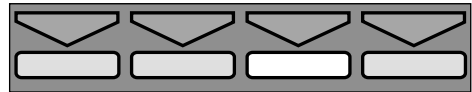
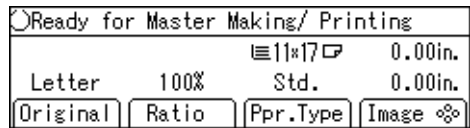

TPES520E

- 2 Make sure that [Std.] is selected.

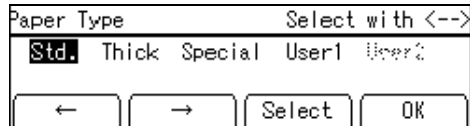

- 3 Press the [OK] key.

## Printing onto Envelopes

1

**1** Press the [Ppr.Type] key.

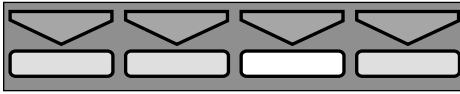

TPES520E

**2** Select [Special] with the [→] or [▷] key.

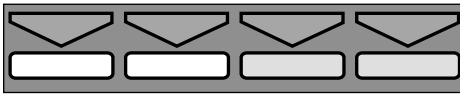

TPES530E

**3** Press the [OK] key.

**4** Place the envelopes in the paper feed tray as shown in the illustration.

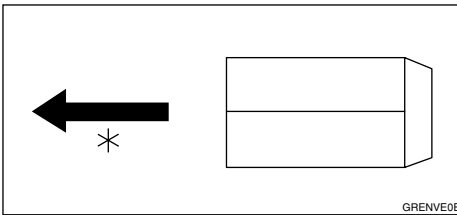

GRENV60E

\* Paper feed direction

### Note

- When you use envelopes, the paper feed tray capacity is about 150 sheets (85g/m<sup>2</sup>, 22 lb) or enough to load a stack up to 105mm, 4.1" high.

**5** If your envelopes do not feed in well, lift the paper feed tray a little, and then lower it so that it slants up slightly.

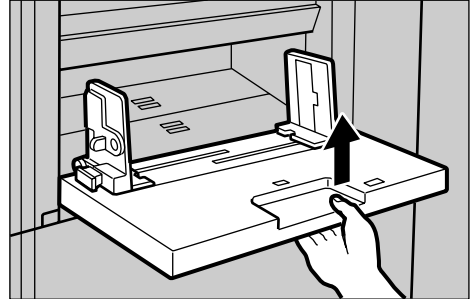

ZFX020E

## Printing onto Special Kinds of Paper

### Preparation

To use this function, you have to register the special paper type in [User1] or [User2] with the user tools. See p.158 "4-19 Type of Paper".

**1** Press the [Ppr.Type] key.

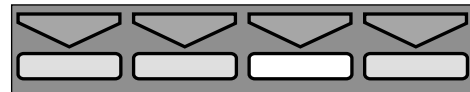
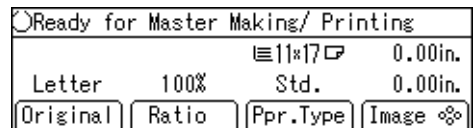

TPES520E

**2** Select [User1] or [User2] with the [←] [→] or [◀] [▶] keys.

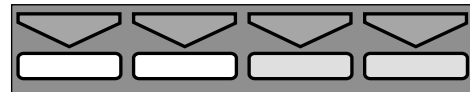
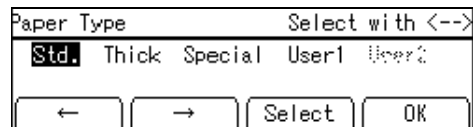

TPES30E

**3** Press the [OK] key.



### To prevent paper misfeeds:

If paper misfeeds occur frequently, even if you have selected a suitable paper, follow the steps below.

- ① Press the **[Select]** key.

Paper Type		Select with <-->	
<b>Std.</b>	Thick	Special	User1 User2
←	→	Select	OK

- ② Select the type of paper misfeed and frequency with the **[◀]**, **[▶]**, **[▲]**, or **[▼]** keys.

Standard	With  Enter	
Mis-Feed :	<b>Std.</b>	Frequent Very frequent
Double Feed:	<b>Std.</b>	Frequent Very frequent
	Cancel	OK

- ③ Press the **[OK]** key.

If paper misfeeds occur frequently in the paper exit section, even if you are using standard or thin paper and have selected **[Std.]**, do the following:

- ① Set the wing guide to the “Down” position with the user tools. See “Deflector Angle” on p.144 “4. Mode Setting”.

If A4 – B5, 8<sup>1</sup>/<sub>2</sub>" × 11" thick paper is not delivered properly to the paper delivery tray, do the following:

- ① Set the wing guide to the “Up” position with the user tools. See “Deflector Angle” on p.144 “4. Mode Setting”.

# Selecting Original Modes

1

Select one of the following five modes to match your originals:

- ❖ **Letter mode**  
Select when originals contain only letters (no pictures).
- ❖ **Letter/Photo mode**  
Select when originals contain photographs or pictures with letters.
- ❖ **Photo mode**  
Select when originals contain photographs or pictures with delicate tones.
- ❖ **Pencil mode**  
Select when originals are written in pencil.
- ❖ **Tint mode**  
Select when you want to make halftone printing.

 **Note**

- ❑ You can adjust the sharpness of text in Letter mode with the user tools. See “Adjusting sharpness of letters” on p.144 “4. Mode Setting”.
- ❑ When using Photo mode to print originals with both text and photographs, the text will appear lighter. To avoid this, select Letter/Photo mode. Alternatively, use the optional Make-up mode to specify Letter mode for text areas and Photo mode for photograph areas.

## Letter/Photo Mode Printing

 **Preparation**

You can adjust the contrast of the image.

**1** Press the **[Original]** key.

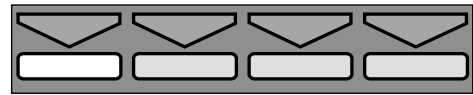

TPES50E

**2** Select **[Letter/Photo]** with the **[→]** or **[▷]** key.

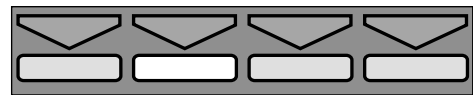

TPES570E

**3** Press the **[Contrast]** key.

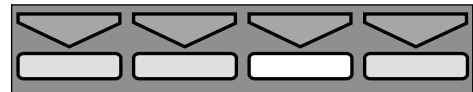

TPES520E

- Adjust the contrast with the [←] [→] or [◀] [▶] keys.

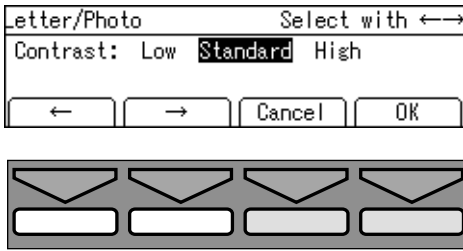

**Note**

- Use "High" to produce clear prints of people's faces.
- Use "Low" to produce clear prints of landscapes and scenery etc.

- Press the [OK] key.
- Place your original on the exposure glass or in the optional document feeder.
- Press the [Start] key.

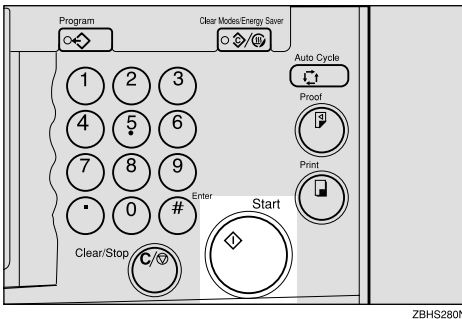

- Check the image position on the trial or proof print.

**Note**

- If the image position is not correct, adjust it using the [Image ⚙] key. See p.24 "Adjusting the Position of Printed Images".

- Make your prints.

## Photo Mode Printing

- Press the [Original] key.

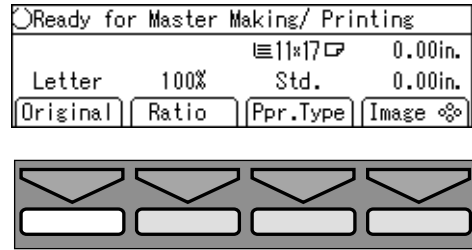

- Select [Photo] with the [→] or [▶] key.

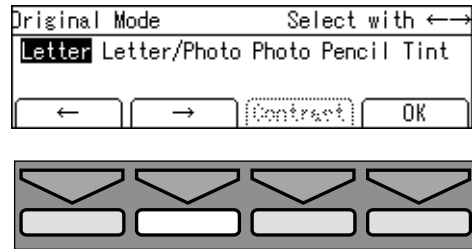

- Press the [OK] key.

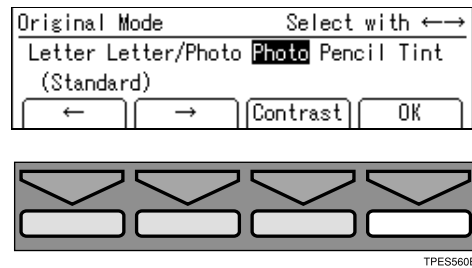

### Adjusting the photo mode contrast

- Press the [Contrast] key.

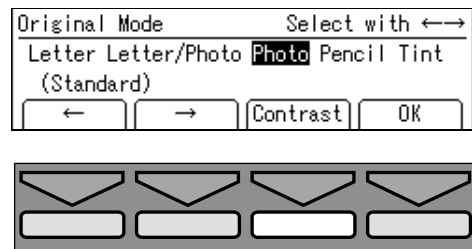

1

**2** Adjust the contrast with the [←][→] or [◀][▶] keys.

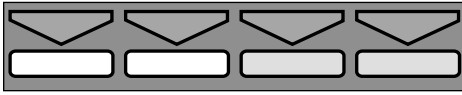
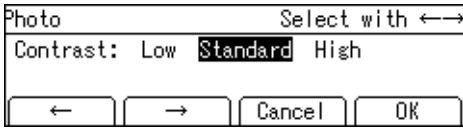

TPES530E

**3** Press the [OK] key.

**Note**

- Use "High" to produce clear prints of people's faces.
- Use "Low" to produce clear prints of landscapes and scenery etc.

**4** Select the dot pattern with the [←][→] or [◀][▶] keys.

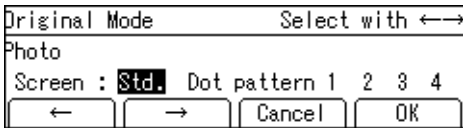

TPES530E

**Note**

- Four dot patterns are available:
  - Setting 1: clearest
  - Setting 2: clearer than setting 3
  - Setting 3: clearer than setting 4
  - Setting 4: clearer than the standard setting

**5** Press the [OK] key.

**6** Place your original on the exposure glass or in the optional document feeder.

**7** Press the [Start] key.

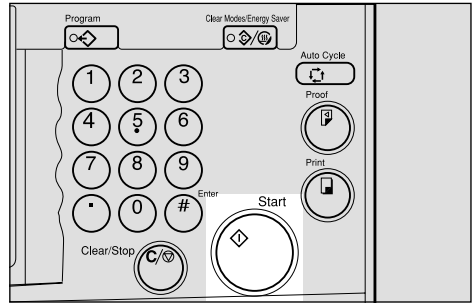

ZBHS280N

**8** Check the image position on the trial or proof print.

**Note**

- If the image position is not correct, adjust it using the [Image ⚙] key. See p.24 "Adjusting the Position of Printed Images".

**9** Make your prints.

## Pencil Mode Printing

**Note**

- Originals written in pencil should be placed on the exposure glass.

**1** Press the [Original] key.

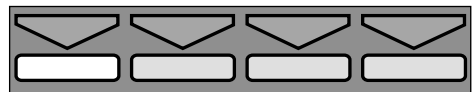
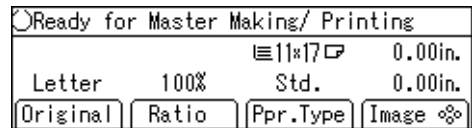

TPES550E

- 2 Select [Pencil] with the [→] or [▷] key.

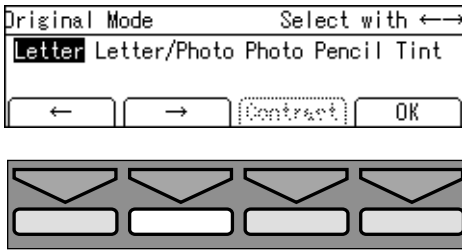

- 3 Press the [OK] key.
- 4 Place your original on the exposure glass.
- 5 Press the [Start] key.

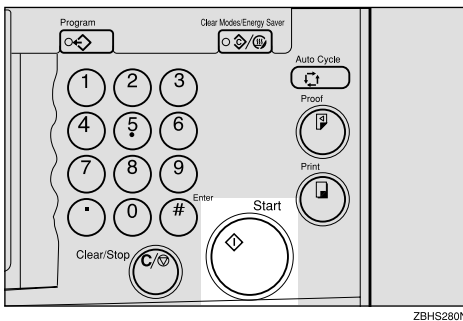

- 6 Check the image position on the trial or proof print.

**Note**

- If the image position is not correct, adjust it using the [Image ⌘] key. See p.24 “Adjusting the Position of Printed Images”.

- 7 Make your prints.

# Economy Mode

When you want to save ink, select Economy mode.

1

## Note

Prints will be lighter in this mode.

**1** Press the **[Economy Mode]** key.

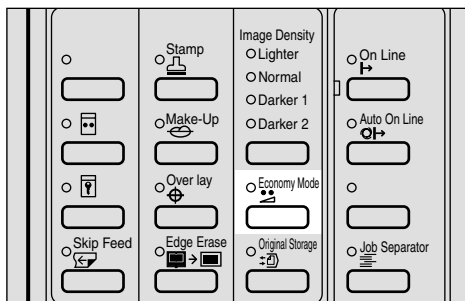

ZDZS020N

**2** Place your original on the exposure glass or in the optional document feeder.

**3** Press the **[Start]** key.

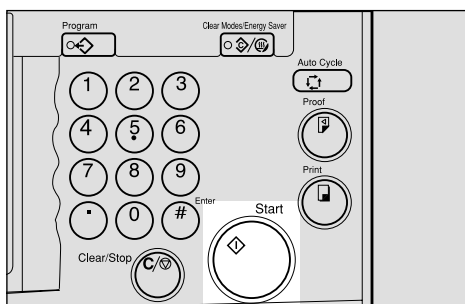

ZBHS280N

**4** Check the image position on the trial or proof print.

## Note

If the image position is not correct, adjust it using the **[Image ⚡]** key. See p.24 "Adjusting the Position of Printed Images".

**5** Make your prints.

# Auto Cycle

Use the **[Auto Cycle]** key to process masters and make prints in a single operation.

- 1** If the indicator of **[Auto Cycle]** key is off, press the **[Auto Cycle]** key.

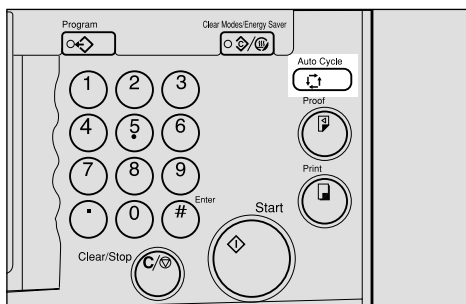

ZBHS490N

- 2** Press the **[Start]** key.

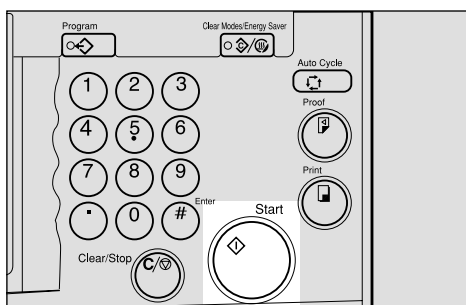

ZBHS280N

# All Class Mode

1

## Preparation

You have to store the number of students in each class with the user tools. See p.154 “3-5 Class Enter No.”.

Use the **[Class]** key to make sets of prints from the same original. All the stored numbers of prints are made for each set.

This feature is useful for teachers who frequently make multiple print sets for classes e.g. notes, handouts, tests etc.

Using a standard print mode, the teacher would have to stand by the machine entering the number of prints and pressing the **[Print]** key for each class. However, All Class mode allows you to store the number of students in each class into the machine memory beforehand with the user tools. Whenever you need to make print sets for all the classes, place your original, select **[ALL]** and press the **[Start]** key. Print sets will be made containing the correct number of prints for each class.

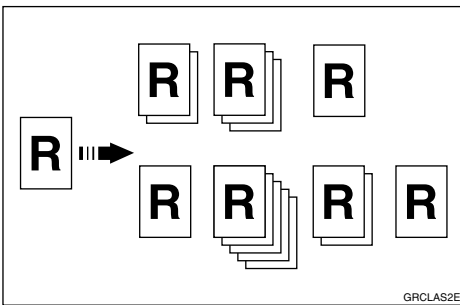

## Note

- ❑ When you choose All Class mode, Job Separation mode is automatically turned on. The job separator pulls the top sheet of the each set delivered to the paper delivery tray to mark the end of each printed set. The next cycle begins automatically. See p.77 “Job Separation”.
- ❑ You can cancel Job Separation mode in All Class mode with the user tools. See “Auto Separate” on p.144 “4. Mode Setting”.

### 1 Press the **[Class]** key.

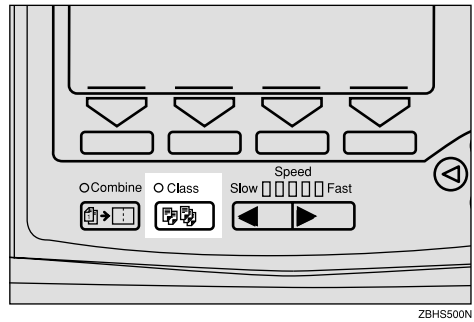

### 2 Make sure that **[ALL]** is selected.

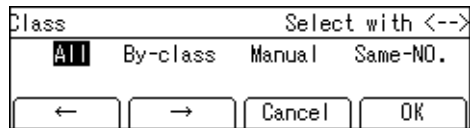

### 3 Press the **[OK]** key.

### 4 Place one original on the exposure glass or in the optional document feeder.



## 5 Press the **[Start]** key.

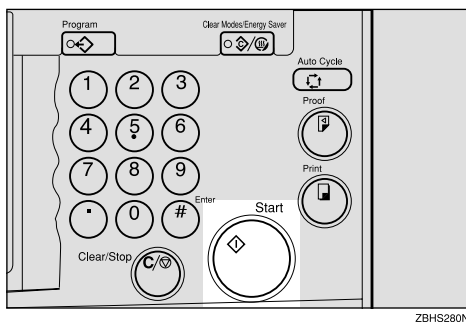

## 6 Check the image position on the trial or proof print.

### Note

- If the image position is not correct, adjust it using the **[Image ❖]** key. See p.24 "Adjusting the Position of Printed Images".

## 7 Make your prints.

# Auto Class Mode

1

## Preparation

You have to store the number of students in each class with the user tools. See p.154 "3-5 Class Enter No."

Use the **[Class]** key to make sets of prints from the same original. The stored numbers of prints are made for each set.

This feature is useful for teachers who frequently make multiple print sets for their classes, e.g. notes, handouts, tests etc.

Using a standard print function, the teacher would have to stand by the machine entering the number of prints and pressing the **[Print]** key for each class. However, Auto Class mode allows you to store the number of students in each class into the machine memory beforehand with the user tools. Then, whenever you need to make print sets for several classes, place your original, select the classes that need prints and press the **[Start]** key. Print sets will be made containing the correct number of prints for each class.

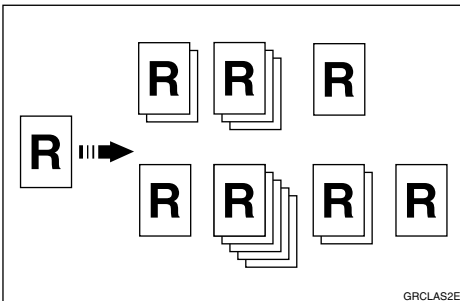

## Note

- When you set Auto Class mode, Job Separation mode is automatically turned on. The job separator pulls the top sheet of the each set delivered to the paper delivery tray to mark the end of each printed set. The next cycle begins automatically. See p.77 "Job Separation".
- You can cancel Job Separation mode in Auto Class mode with the user tools. See "Auto Separate" on p.144 "4. Mode Setting".

**1** Press the **[Class]** key.

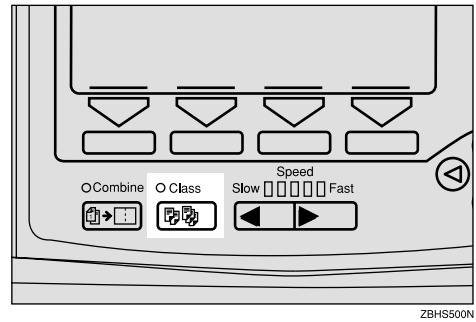

**2** Select **[By-class]** with the **[→]** or **[▷]** key.

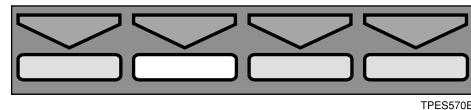
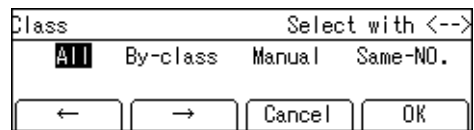

**3** Press the **[OK]** key.

- 4** Select the desired classes for each grade.

Select Class with  , Enter				
1	:	ALL	1 2 3 4	
2	:	ALL	1 2 3 4	
		Prev.	Next	Select OK

Selecting classes with the [**◀**], [**▶**], [**▲**], or [**▼**] key

- 1** Select the desired class for the 1<sup>st</sup> grade with the [**▶**] key.

The number of students is displayed on the counter.

 **Note**

- When you want to select all the classes, select [**ALL**].

- 2** Press the [**Select**] key.

 **Note**

- Repeat steps **1** and **2** until you have finished designating classes for the 1st grade.
- To cancel a class selection, select that class with the [**◀**], [**▶**], [**▲**], or [**▼**] key, and then press the [**Cancel**] key.
- When you want to select many classes for one grade, first select [**ALL**] and press the [**Select**] key, and then deselect the unnecessary classes with the [**Cancel**] key.

- 3** Press the [**▼**] key.

Now you can select classes for the 2<sup>nd</sup> grade.

- 4** Select the desired class for the 2<sup>nd</sup> grade with the [**◀**], [**▶**], [**▲**], or [**▼**] key.

- 5** Press the [**Select**] key.

 **Note**

- Repeat steps **3** to **5** until you have finished designating all the desired classes.

Selecting classes with the number keys

- 1** Enter the desired grade and class with the number keys.

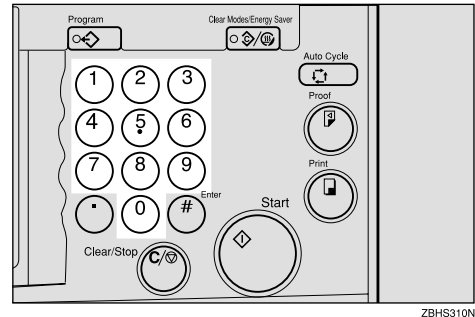

 **Note**

- For example, to select grade 2 class 4, enter 24.
- When you want to select all the classes for one grade, enter the grade number followed by 0.

- 2** Press the [**#**] key.

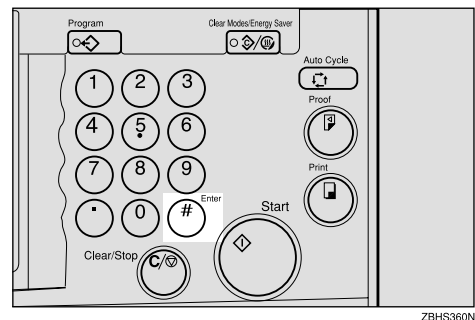

 **Note**

- To cancel a class, select that class with the [**◀**], [**▶**], [**▲**], or [**▼**] key, and then press the [**Cancel**] key.
- Repeat steps **1** and **2** until you have finished selecting all the desired classes.

- 5** Press the [**OK**] key.

**6** Place one original on the exposure glass or in the optional document feeder.

1

**7** Press the **[Start]** key.

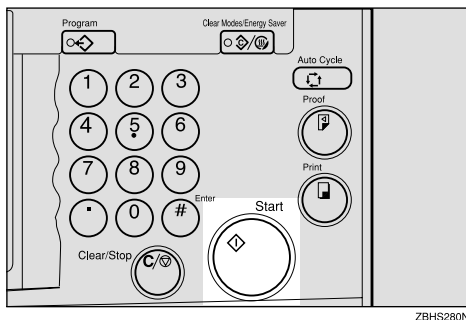

**8** Check the image position on the trial or proof print.

**Note**

- If the image position is not correct, adjust it using the **[Image ⚙]** key. See p.24 "Adjusting the Position of Printed Images".

**9** Make your prints.

# Manual Class Mode with One Original

Use the **[Class]** key to make sets of prints from the same original. Various numbers of prints are made for each set.

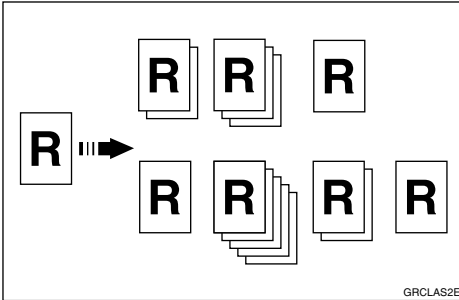

## Note

- When you set the Manual Class mode, Job Separation mode is automatically turned on. The job separator pulls the top sheet of each set delivered to the paper delivery tray to mark the end of each printed set. The next cycle begins automatically. See p.77 "Job Separation".
- To stop Job Separation mode from automatically turning on, use the user tools. See "Auto Separate" on p.144 "4. Mode Setting".

## 1 Press the **[Class]** key.

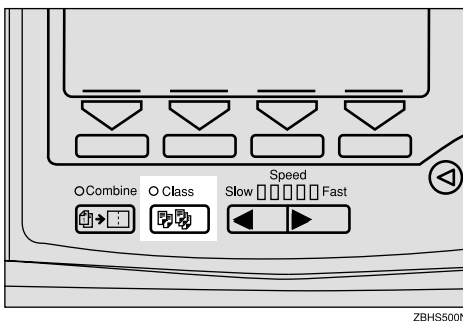

## 2 Select **[Manual]** with the **[→]** or **[▷]** key.

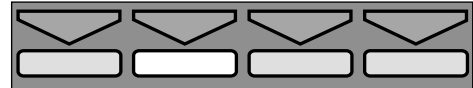
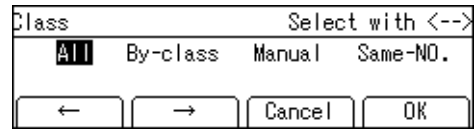

## 3 Press the **[OK]** key.

## 4 Enter the desired number of prints for the first set with the number keys.

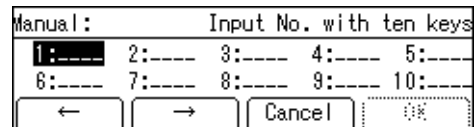

## 5 Press the **[#]** key.

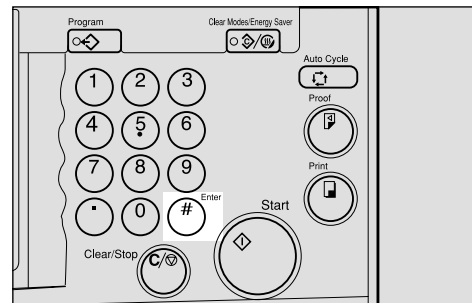

1

**6** Enter the desired number of prints for the second set with the number keys.

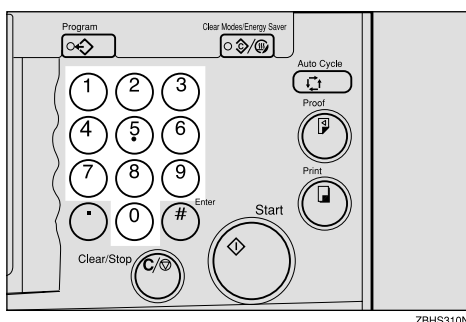

ZBHS310N

**12** Make your prints.

**7** Press the [#] key.

**Note**

- Repeat steps **6** and **7** for each set.
- The maximum number of sets that can be made is 20.

**8** Press the [OK] key.

**9** Place one original on the exposure glass or in the optional document feeder.

**10** Press the [Start] key.

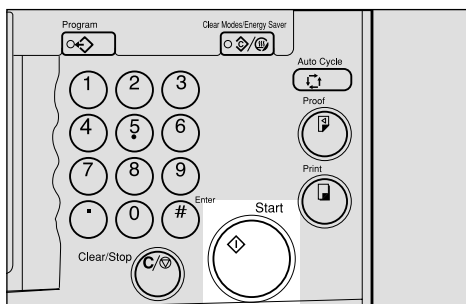

ZBHS280N

**11** Check the image position on the trial or proof print.

**Note**

- If the image position is not correct, adjust it using the [Image ❖] key. See p.24 "Adjusting the Position of Printed Images".

# Manual Class Mode with two or More Originals

## Preparation

To use this function, you have to select “by each original” with the “Class Manual Set” setting in the user tools. See “Class Manual Set” on p.144 “4. Mode Setting”.

Use the **[Class]** key to make sets of prints from different originals. Various numbers of prints are made for each set.

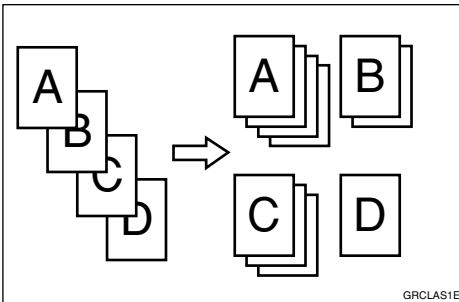

## Note

- ❑ When you set Manual Class mode, Job Separation mode is automatically turned on. The job separator pulls the top sheet of each set delivered to the paper delivery tray to mark the end of each printed set. The next cycle begins automatically. See p.77 “Job Separation”.
- ❑ You can suspend Job Separation mode whenever you set the Manual Class mode with the user tools. See “Auto Separate” on p.144 “4. Mode Setting”.
- ❑ With the optional document feeder, you can place several originals and make prints of all of them at once. See p.128 “Manual Class Mode with Two or More Originals”.

## 1 Press the **[Class]** key.

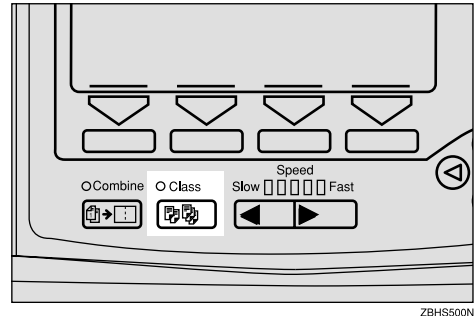

## 2 Select **[Manual]** with the **[→]** or **[▷]** key.

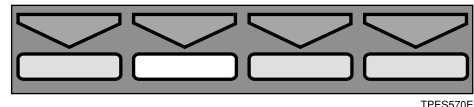
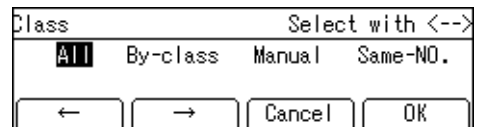

## 3 Press the **[OK]** key.

## 4 Enter the desired number of prints for the first original with the number keys.

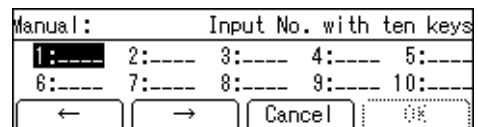

## 5 Press the **[#]** key.

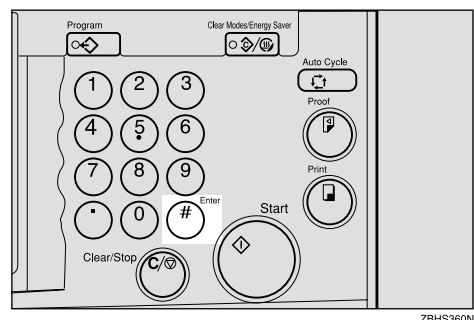

1

**6** Enter the desired number of prints for the second original with the number keys.

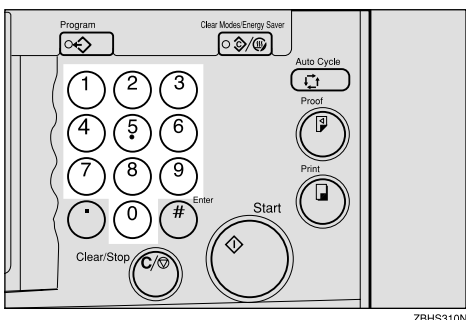

**7** Press the [#] key.

**Note**

- Repeat steps **6** and **7** for each original.
- Up to 20 classes can be set.

**8** Press the [OK] key.

**9** Place the first original face down on the exposure glass.

**10** Press the [Start] key.

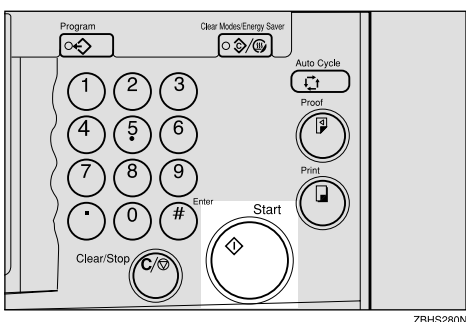

**11** Check the image position on the trial or proof print.

**Note**

- If the image position is not correct, adjust it using the [Image ] keys. See p.24 "Adjusting the Position of Printed Images".

**12** Press the [Auto Cycle] key.

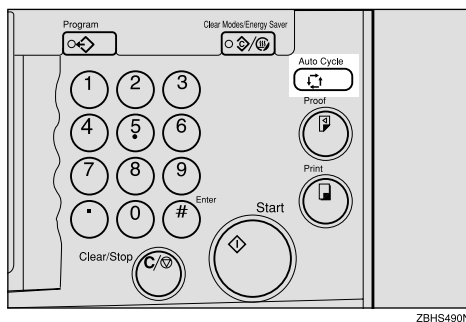

**13** Press the [Print] key.

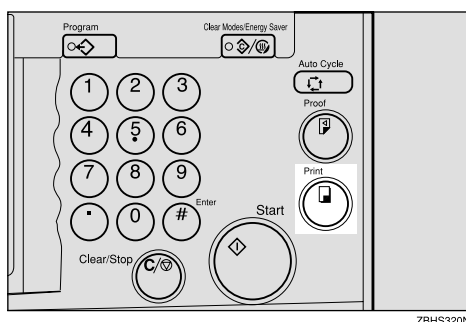

**14** After the first set is completed, place the second original on the exposure glass, and then press the [Start] key.

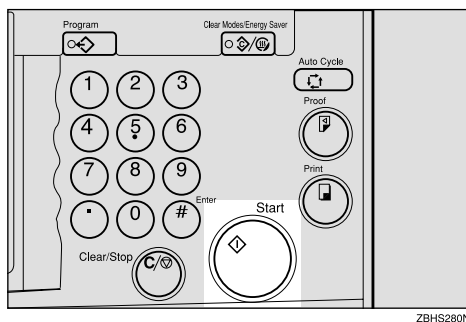

**Note**

- Repeat step **14** until you have finished printing.



# Class Mode

Use the **[Class]** key to make sets of prints from the same original. The same numbers of prints are made for each set.

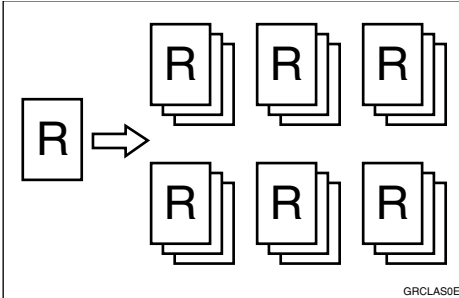

## Note

- ❑ When you choose Class mode, Job Separation mode is automatically turned on. The job separator pulls the top sheet of each set delivered to the paper delivery tray to mark the end of each printed set. The next cycle begins automatically. See p.77 "Job Separation".
- ❑ You can suspend Job Separation mode whenever you set the Class mode with the user tools. See "Auto Separate" on p.144 "4. Mode Setting".

## 1 Press the **[Class]** key.

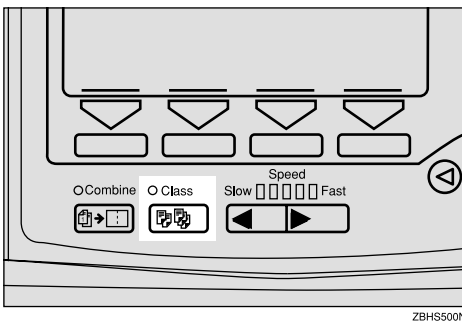

## 2 Select **[Same-NO.]** with the **[→]** or **[▷]** key.

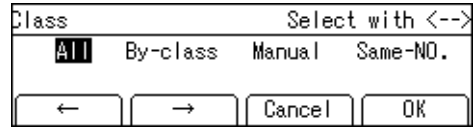

## 3 Press the **[OK]** key.

## 4 With the number keys, enter the desired number of prints for each set.

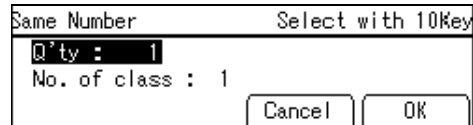

## 5 Press the **[#]** key.

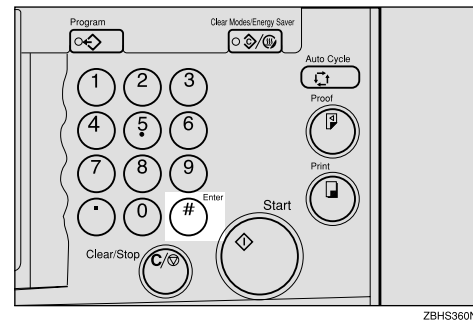

1

**6** With the number keys, enter the number of sets you wish to make.

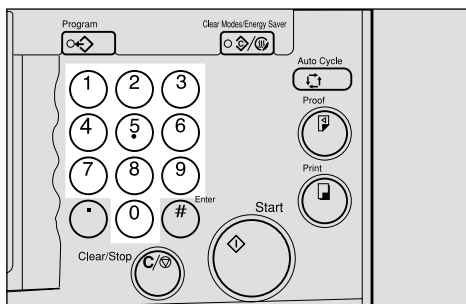

**Note**

- Up to 99 sets can be selected for an original.

**7** Press the [OK] key.

**8** Place one original on the exposure glass or in the optional document feeder.

**9** Press the [Start] key.

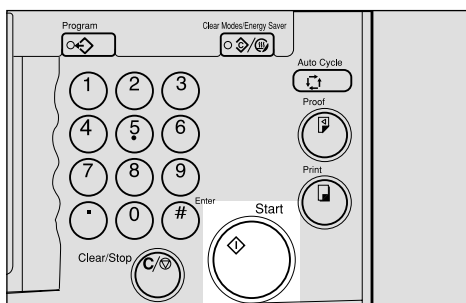

**10** Check the image position on the trial or proof print.

**Note**

- If the image position is not correct, adjust it using the [Image ] key. See p.24 "Adjusting the Position of Printed Images".

**11** Make your prints.

# Combine Originals

You can combine originals in two ways:

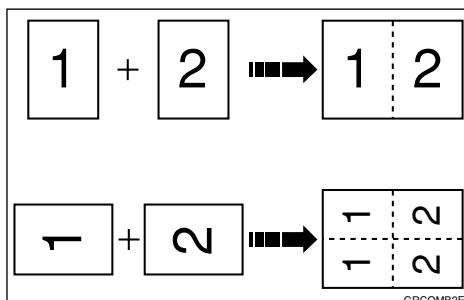

## ❖ 2 single-sided originals → 1 single-sided print with 2 images

Combine two single-sided originals onto one single-sided print with the two images placed side-by-side.

## ❖ 2 single-sided originals → 1 single-sided print with 4 images

Combine two single-sided originals onto one single-sided print with each image duplicated (total of four images).

### Note

- You can also use Memory Combine mode. See p.115 “Memory Combine”.
- You can set the machine to cancel Combine Originals mode after finishing your print job with the user tools. See “Cancel Comb.” on p.144 “4. Mode Setting”.
- Any image closer than 8mm, 0.32" to the leading edge of the first original will not be printed. Any image closer than 4mm, 0.16" to the leading edge of the second original will also not be printed. When the image is too close to the leading edge, use copies of the originals with the image shifted at least 8mm, 0.32" for the first original (4mm, 0.16" for the second original) from the leading edge.
- You can select different image settings for the first and second original.
- Make sure that the paper feed side plates touch the paper lightly and that the paper size and direction shown on the panel display match the size and direction of paper actually placed in the paper feed tray. Either case can cause the two original images not to appear in the proper position on prints.
- The following tables list the combinations that can be used with the Combine feature (2 single-sided originals → 1 single-sided print with 2 images).

❖ Metric version

		Original Size				
		A4	B5	A5	B6	A6
Paper Size	A3	100%	115%	141%	163%	200%
	B4	87%	100%	122%	141%	173%
	A4	71%	82%	100%	115%	141%
	B5	61%	71%	87%	100%	122%
	A5	50%	58%	71%	82%	100%

❖ Inch version

		Original Size	
		8 1/2" × 11"	5 1/2" × 8 1/2"
Paper Size	11" × 17"	100%	129%
	8 1/2" × 14"	77%	100%
	8 1/2" × 11"	65%	100%
	5 1/2" × 8 1/2"	50%	65%

□ The following tables list the combinations that can be used with the Combine feature (2 single-sided originals → 1 single-sided print with 4 images).

❖ Metric version

		Original Size						
		A3	B4	A4	B5	A5	B6	A6
Paper Size	A3	50%	58%	71%	82%	100%	115%	141%
	B4	-	50%	61%	71%	87%	100%	122%
	A4	-	-	50%	58%	71%	82%	100%
	B5	-	-	-	50%	61%	71%	87%
	A5	-	-	-	-	50%	58%	71%

❖ Inch version

		Original Size			
		11" × 17"	8 1/2" × 14"	8 1/2" × 11"	5 1/2" × 8 1/2"
Paper Size	11" × 17"	50%	65%	65%	100%
	8 1/2" × 14"	-	50%	50%	77%
	8 1/2" × 11"	-	-	50%	77%
	5 1/2" × 8 1/2"	-	-	-	50%

- If a suitable reproduction ratio is not selected, images might not completely appear on prints.
- Originals reading from left to right.

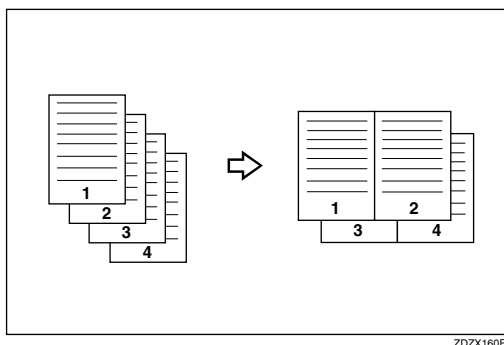

### Reference

When you use the optional document feeder with this function, see p.127 “Combine Printing”.

### **1** Place the first original face down.

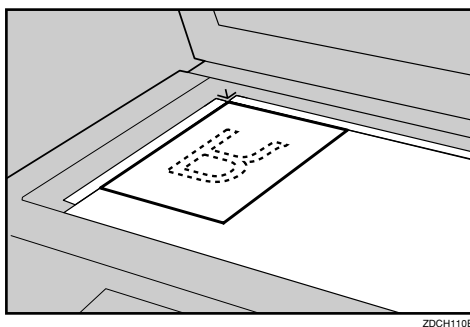

### Note

- When you place an original sideways () , the top should be toward the operation panel as shown above.

### **2** Enter the number of prints using the number keys.

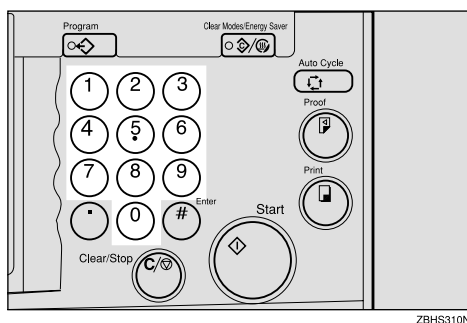

1

**3** Check the print paper size and the reproduction ratio.

**Note**

- To have the machine choose a suitable ratio automatically, use Auto Magnification mode. See p.31 “Auto Magnification”.

**4** Press the **[Combine]** key.

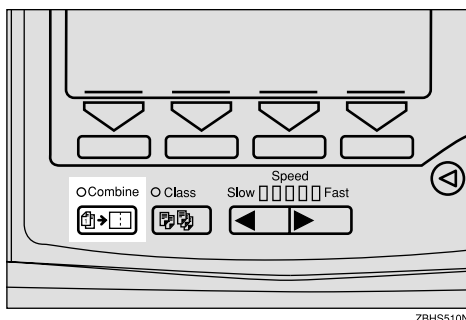

**5** Select **[Combine 2]** or **[Quadruple]** with the **[←]** **[→]** or **[◀]** **[▶]** keys.

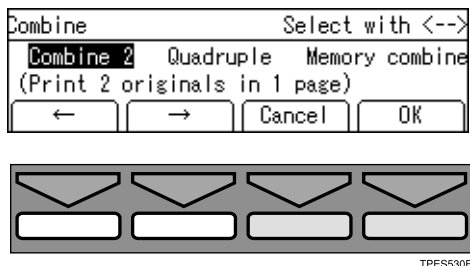

**6** Press the **[OK]** key.

**7** Press the **[Start]** key.

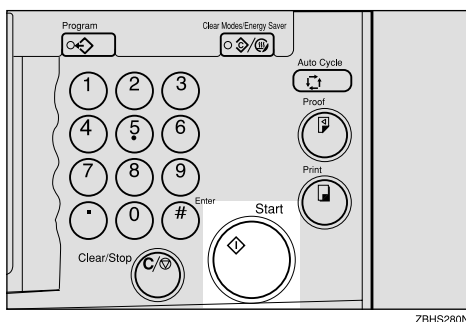

- 8 The beeper sounds after the first original has been stored. Place the second original face down.

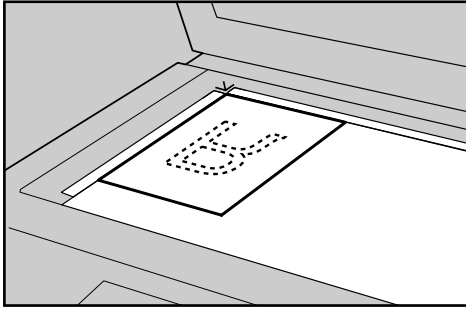

- 9 Press the **[Start]** key.
- 10 Check the image position on the trial or proof print.

 **Note**

- If the image position is not correct, adjust it using the **[Image ⌘]** key. See p.24 "Adjusting the Position of Printed Images".

- 11 Make your prints.

# Auto Combine Mode

1

## Preparation

To use this function, you have to select Auto Combine mode with the user tools. See "Combine" on p.144 "4. Mode Setting".

You can have images duplicated in two ways:

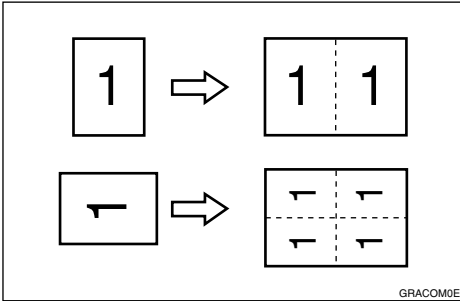

### ❖ 1 single-sided original → 1 single-sided print of 2 images

The original image is duplicated twice on one print.

### ❖ 1 single-sided originals → 1 single-sided print of 4 images

The original image is duplicated four times on one print.

## Reference

See p.63 "Combine Originals" for details.

## 1 Place your original on the exposure glass or in the optional document feeder.

## 2 Enter the number of prints using the number keys.

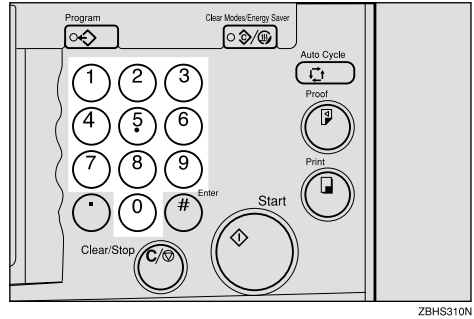

## 3 Check the print paper size and the reproduction ratio.

### Note

To have the machine choose a suitable ratio automatically, use Auto Magnification mode. See p.31 "Auto Magnification".

## 4 Press the [Combine] key.

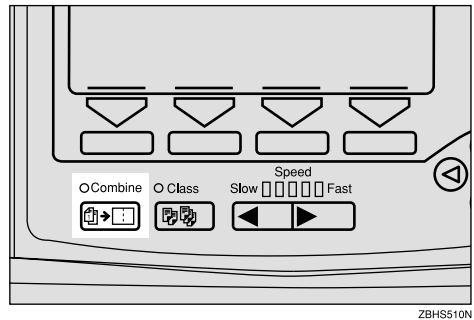

## 5 Select [Repeat 2] or [Repeat 4] with the [←] [→] or [◀] [▶] keys.

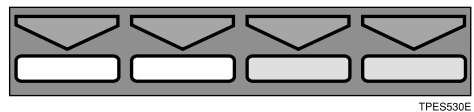
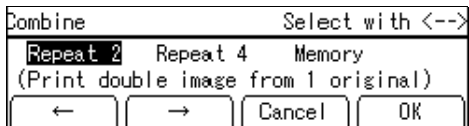



**6** Press the [OK] key.

**7** Press the [Start] key.

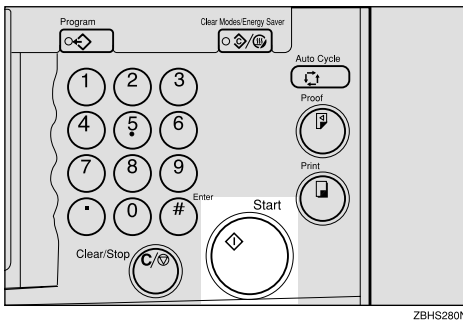

**8** Check the image position on the trial or proof print.

 **Note**

- If the image position is not correct, adjust it using the [Image ] key. See p.24 "Adjusting the Position of Printed Images".

**9** Make your prints.

# Skip Feed Printing

1

You can increase the time between prints using the **[Skip Feed]** key. By default, when one sheet of paper is fed, the drum rotates twice. However, you can select the number of drum rotations. This gives you a chance to remove prints one by one from the paper delivery tray or insert one sheet of paper between two prints. If you use this function, you can also use paper longer than the length limitation of 432mm, 17.0".

**Note**

- For every sheet of paper fed, the drum rotates twice by default. You can change this default setting with the user tools. See "No. of Skip Feed" on p.144 "4. Mode Setting".
- The maximum length of paper in Skip Feed mode is 460mm, 18.1".
- When you use paper longer than 432mm, 17.0", prints will not be delivered to the paper delivery tray properly, so lower the paper delivery end plate and take out the prints by hand.

**1** Place your original on the exposure glass or in the optional document feeder.

**2** Press the **[Skip Feed]** key.

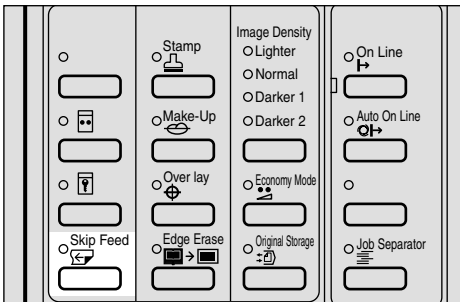

ZDZS030N

**3** If necessary select the number of drum rotations per sheet of paper fed with the **[←]** **[→]** or **[<]** **[>]** keys.

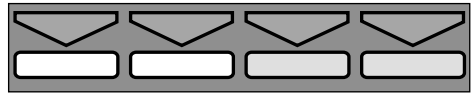
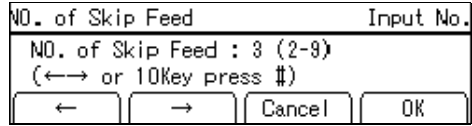

TPES530E

**Note**

- You can also select the number of rotations with the number keys.
- You can select from 2 to 9 rotations.
- By default, the machine asks you to confirm the number of rotations. You can have this step omitted by adjusting the user tool settings. See "No. of Skip Feed" on p.144 "4. Mode Setting".

**4** Press the **[OK]** key.

**5** Press the **[Start]** key.

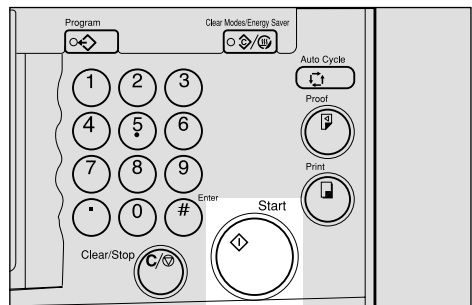

ZBHS280N

## **6** Check the image position on the trial or proof print.

### **Note**

- If the image position is not correct, adjust it using the **[Image ⌘]** key. See p.24 “Adjusting the Position of Printed Images”.

## **7** Make your prints.

### **Note**

- After printing is completed, the Skip Feed setting returns to the default.

# Programs

1

You can store up to 9 frequently used print job settings in machine memory and recall them for future use.

**Note**

- Stored programs are not cleared when you turn off the main switch.
- Stored programs cannot be deleted. If you want to change a stored program, overwrite it.

## Storing a Program

**1** Make the print settings you want to put into memory.

**2** Press the **[Program]** key.

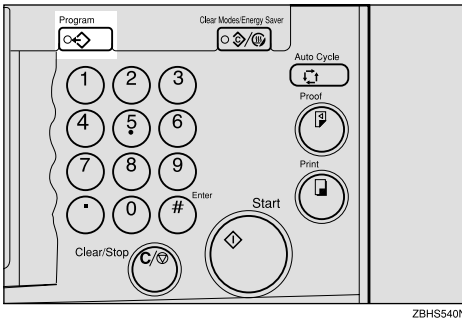

ZBHS540N

**3** Select **[Store]** with the **[→]** or **[▷]** key.

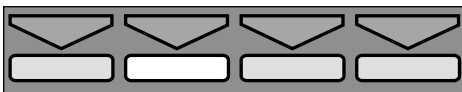
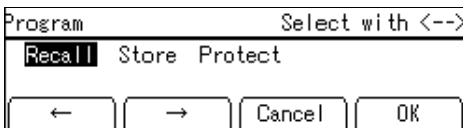

TPES570E

**4** Press the **[OK]** key.

**Note**

- The program numbers (1 to 9) will be displayed in the panel display.
- If a user program has been protected, that program number will not appear in the panel display. To change a protected user program, see p.73 "Protecting a Program".
- If all the user programs have been protected, you cannot store any settings. Press the **[Cancel]** key.

**5** Select the program number you want to store the settings in with the **[←]** **[→]** or **[◀]** **[▶]** keys.

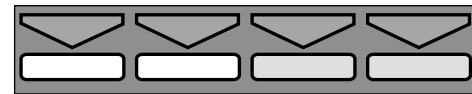
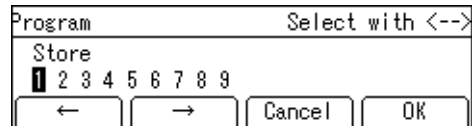

TPES30E

**Note**

- You can also select the program number with the number keys.

**6** Press the **[OK]** key.

**Note**

- If this program number is already used, the machine asks whether you wish to overwrite it or not. Press the **[Yes]** or **[No]** key.

## Protecting a Program

If you want to prevent someone from writing over your program, do the following:

- 1 Press the **[Program]** key.

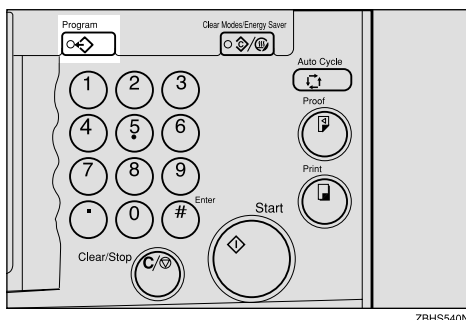

ZBH540N

- 2 Select **[Protect]** with the **[→]** or **[▷]** key.

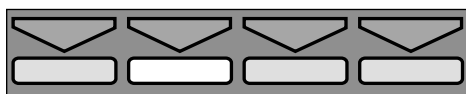
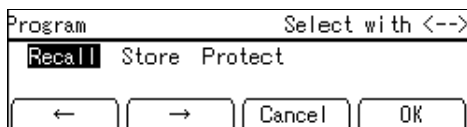

TPES570E

- 3 Press the **[OK]** key.

- 4 Select the program number you want to protect with the **[←]** **[→]** or **[◀]** **[▶]** keys.

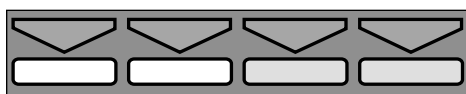
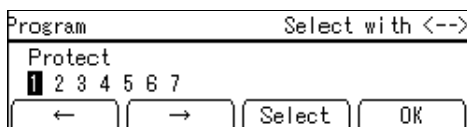

TPES530E

### Note

- Already protected program numbers are shown with a black background (e.g. **1**).
- You can also select the program number with the number keys.

- 5 Press the **[Select]** key.

- 6 Press the **[OK]** key.

## Removing Program Protection

- 1 Press the **[Program]** key.

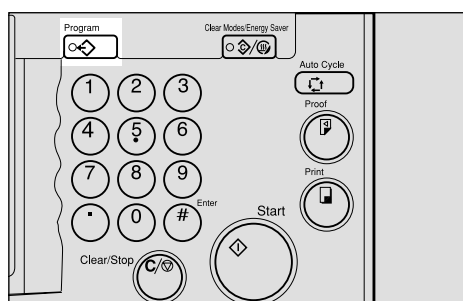

ZBH540N

- 2 Select **[Protect]** with the **[→]** or **[▷]** key.

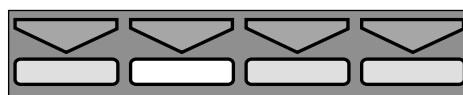
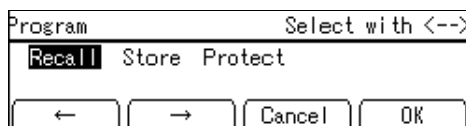

TPES570E

- 3 Press the **[OK]** key.

- 4 Select the program number you want to remove protection from with the **[←]** **[→]** or **[◀]** **[▶]** keys.

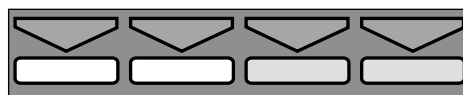
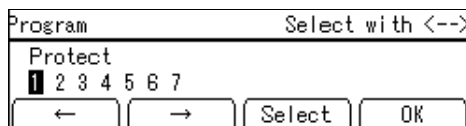

TPES530E

### Note

- Already protected program numbers are shown with a black background (e.g. **1**).
- You can also select the program number with the number keys.

**5** Press the [Select] key.

**6** Press the [OK] key.

## Recalling a Program

**1** Press the [Program] key.

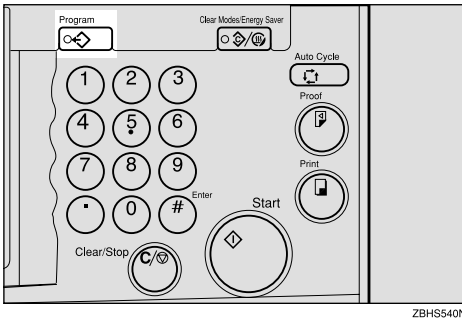

**2** Make sure that [Recall] is selected.

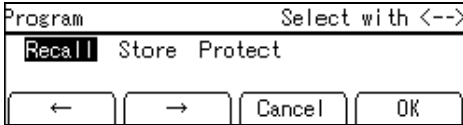

**3** Press the [OK] key.

**Note**

- Programs that have been stored beforehand are represented by a number.

**4** Select the program number you want to recall with the [←] [→] or [◀] [▶] keys.

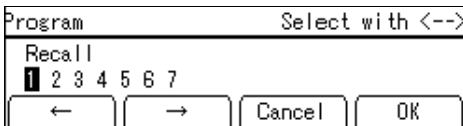

**Note**

- You can also select the program number with the number keys.

**5** Press the [OK] key.

**6** Place your original on the exposure glass or in the optional document feeder.

**7** Press the [Start] key.

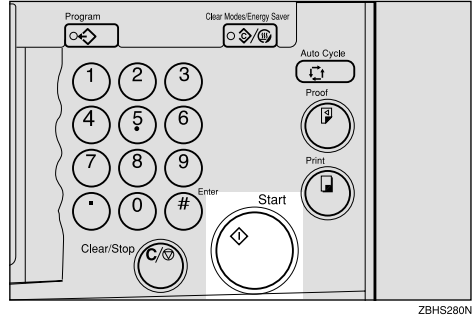

# Security Mode

This function prevents others from making prints of confidential documents from the master. For example, if you want to print some documents with sensitive information, use this function after making your prints so that nobody can access that master again.

**1** Make your prints.

**2** Press the **[Security]** key.

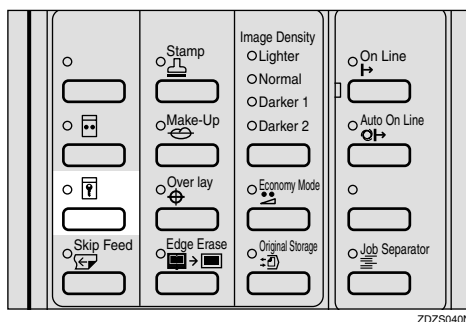

**3** Press the **[Yes]** key.

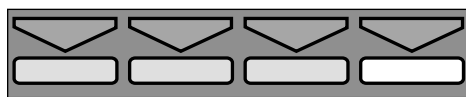
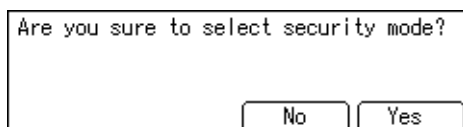

## Note

- If you set Security Mode, you cannot make prints after finishing one job even if you press the **[Proof]** key or **[Print]** key. Press the **[Exit]** key.
- You cannot cancel Security mode even if you turn off the main switch.
- Security mode is canceled when you make a new master.
- You cannot pull out the drum unit when in security mode.

# Quality Start Mode

1

If the machine is not used for a long period of time or you change the color drum unit, the ink on the drum might dry causing print quality to deteriorate. To solve this problem, you can have the machine carry out a few idle spins of the drum before a print run. This will restore image quality and save you having to make a repeat print run.

You can use this feature in two ways:

## ❖ Manual Quality Start

Choose Quality Start mode for the next print run manually using the **【Quality Start】** key.

## ❖ Auto Quality Start

Have the machine check automatically how long ago it was used before each print run. If the machine has not been used for a long time, Quality Start will be used for the print job. By default, Auto Quality Start mode is on. You can turn it off with the user tools. See “Setting Q.start” on p.144 “4. Mode Setting”.

## Note

- ❑ You can change the number of spins in Manual Quality Start mode with the user tools. See “Idling for Q.start” on p.144 “4. Mode Setting”.
- ❑ You can change the number of spins after the fixed time period has passed in Auto Quality Start mode with the user tools. See “No. of Q.start” on p.144 “4. Mode Setting”.

## Using Quality Start Manually

### 1 Press the **【Quality Start】** key.

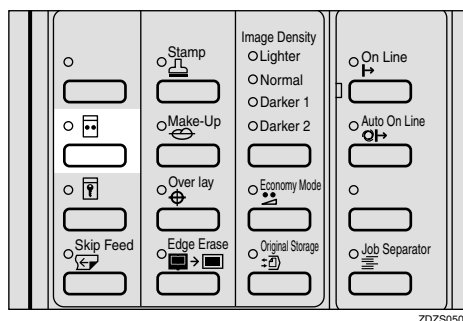

### 2 Place your original on the exposure glass or in the optional document feeder.

### 3 Press the **【Start】** key.

The drum unit idles.

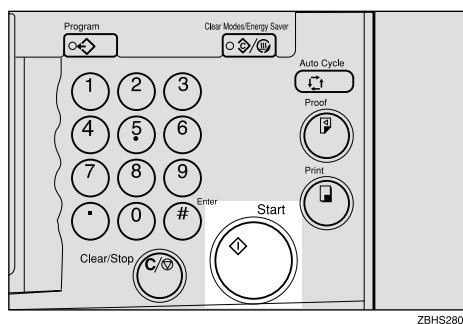

### 4 Make your prints.



# Job Separation

The print on the top of each print set in the paper delivery tray is pulled by the job separator. This function is useful when you make two or more print sets.

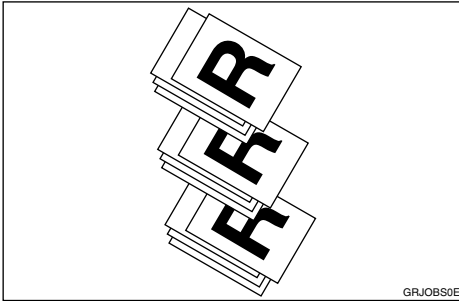

## ⚠ CAUTION:

- While printing, do not touch the belt at the end of the paper delivery tray or the job separator. Otherwise, an injury might occur.

## 💡 Limitation

- In Job Separation mode, the following limitations apply.

### ❖ Metric version

Minimum paper size	Maximum paper weight	Paper delivery tray capacity
Length: 210mm Width: 128mm	127.9g/m <sup>2</sup>	600 sheets (64g/m <sup>2</sup> )

### ❖ Inch version

Minimum paper size	Maximum paper weight	Paper delivery tray capacity
Length: 8.3" Width: 5.1"	34 lb	600 sheets (17 lb)

## 📝 Note

- When you use thin paper, it is not recommended to use Job Separation mode. The job separator might tear the paper.
- If the job separator touches the print image, prints might be marked. In this case, it is not recommended to use Job Separation mode.
- When you do not use Job Separation mode, you can select the machine condition after each print set is fed out to the paper delivery tray with the user tools. See "Auto Class" on p.144 "4. Mode Setting".
- If there are less than 10 sheets of paper in the paper delivery tray, the machine may not be able to use Job Separation mode.

**1** Press the **[Job Separator]** key.

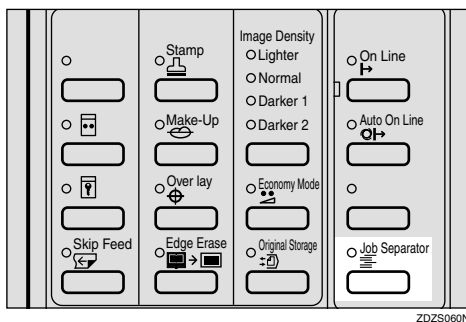

**2** Make your prints.

**Note**

- After the last page of each print set is fed out to the paper delivery tray, the job separator pulls the last sheet of each group in Job Separation mode. The next job separation begins.

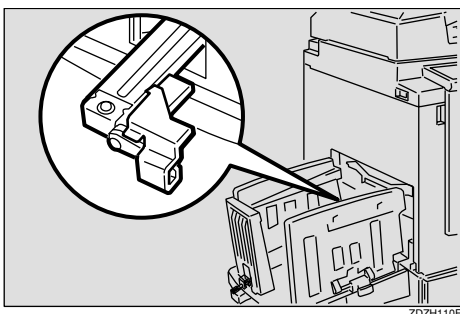

# Conserving the Master

The machine automatically changes the master length depending on the paper size you use. This saves both master and ink.

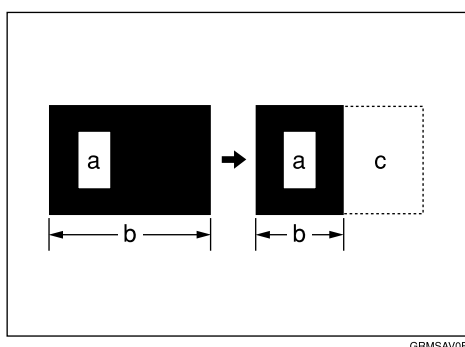

GRMSAVE

a = Images on the master

b = Masters

c = Conserved area

## ! Limitation

- The optional document feeder is required.

## 📝 Note

- This function is turned on when you use A4 , 8<sup>1</sup>/<sub>2</sub>" × 11"  or B5  paper and you set 2 or more originals in the optional document feeder.
- This function does not apply to the last page.
- You can cancel Master Saving mode with the user tools. See "Master length" on p.144 "4. Mode Setting". You can also save master using the optional A4, 8<sup>1</sup>/<sub>2</sub>" × 11" drum. See p.134 "Changing the Drum Size".

# On Line Printing

On Line printing allows you to use this machine as a PC printer.

**Limitation**

- The optional PC controller is required.

**Note**

- Before printing onto A5, 5 1/2" x 8 1/2", or non-standard size paper, you need to select the paper size with the [Pnt.Size] key.
- When printing onto thick paper, thin paper or special kinds of paper from the paper feed tray, select the paper type before pressing the [On Line] key. See p.43 "Printing onto Various Kinds of Paper".

**1 Press the [On Line] key.**

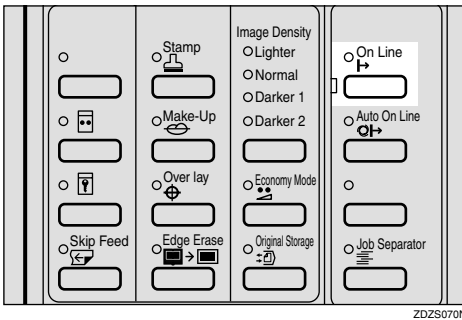

**When a print job has not finished printing while in online mode**

If a print job has not finished printing and the job is interrupted, the machine cannot receive data from the PC. To print the next job from the PC, cancel the interrupted print job.

**1 Press the [fin PRNT] key.**

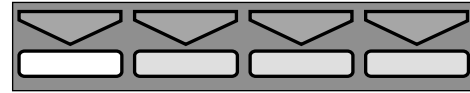
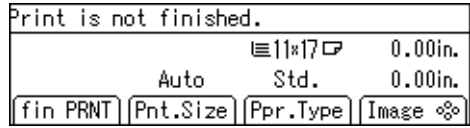

**When printing onto A5, 5 1/2" x 8 1/2", or non-standard paper sizes**

**1 Press the [Pnt.Size] key.**

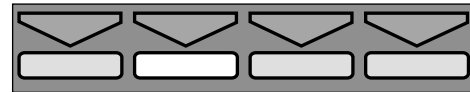
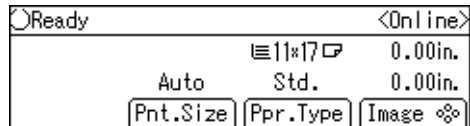

**2 Select A5, 5 1/2" x 8 1/2", or Custom (non-standard) with the [←] or [→] key.**

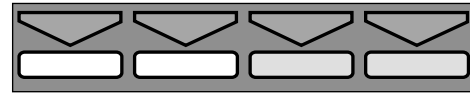
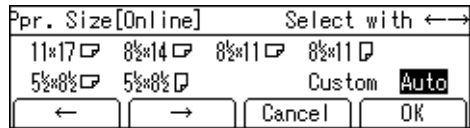

**3 Press the [OK] key.**

**When printing onto standard paper sizes or sizes other than A5, 5 1/2" x 8 1/2"**

**1 Refer to the PC controller manual.**

## Auto On Line

You can select whether the machine automatically switches to On Line mode when it receives data from a PC.

### Preparation

- The default setting for On Line mode is On. However, you can change the setting to Off if required.
- You can press the **【Auto On Line】** key to switch Auto On Line on or off. If the Auto On Line indicator is lit, Auto On Line is active. If the indicator is off, Auto On Line is inactive.
- When the Auto On Line indicator is lit, Auto On Line has priority when data is received from a PC. If you want to prevent the machine from interrupting a print job when it receives data from a PC, press the **【Auto On Line】** key so the Auto On Line indicator goes off and Auto On Line becomes inactive.

### **1** Press the **【Auto On Line】** key.

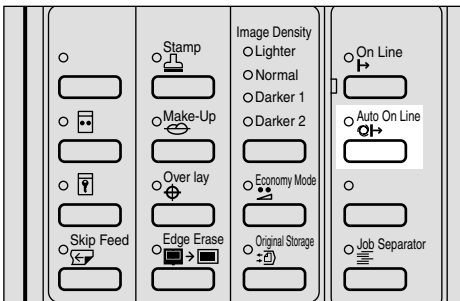

ZDZS160N

# Image Rotation

1

When your original setting direction is different from the paper direction, the machine automatically rotates the original image by 90° to match the paper direction.

## Note

- The following tables list the combinations that can be used in Image Rotation mode.

### ◆ Metric version

Original	A3	B4	A4	A4	B5	B5	A5☆	A5☆
Paper								
A4	--	--	--	★	--	★	--	★
A4	★	★	★	--	★	--	★	--
B5	--	--	--	★	--	★	--	★
B5	★	★	★	--	★	--	★	--
A5	--	--	--	★	--	★	--	★
B6	--	--	--	★	--	★	--	★

★: The machine automatically rotates the original image by 90° to match the paper direction.

☆: Place these originals in the optional document feeder.

### ◆ Inch version

Original	11" × 17"	8 <sup>1</sup> / <sub>2</sub> " × 14"	8 <sup>1</sup> / <sub>2</sub> " × 11"	8 <sup>1</sup> / <sub>2</sub> " × 11"	5 <sup>1</sup> / <sub>2</sub> " × 8 <sup>1</sup> / <sub>2</sub> "	5 <sup>1</sup> / <sub>2</sub> " × 8 <sup>1</sup> / <sub>2</sub> "
Paper						
8 <sup>1</sup> / <sub>2</sub> " × 11"	--	--	--	★	--	★
8 <sup>1</sup> / <sub>2</sub> " × 11"	★	★	★	--	★	--
5 <sup>1</sup> / <sub>2</sub> " × 8 <sup>1</sup> / <sub>2</sub> "	--	--	--	★	--	★

★: The machine automatically rotates the original image by 90° to match the paper direction.

☆: Place these originals in the optional document feeder.

## Note

- If you use Zoom mode, non-standard size originals or paper, the image will not be rotated.
- It takes longer than usual to make masters in Image Rotation mode.
- You can cancel Image Rotation mode with the user tools. See "Auto Rotation" on p.144 "4. Mode Setting".

# Make-up Printing Features

*The optional editing function is required for this feature.*







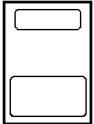

Make-up mode enables you to do more than just make an exact copy of the original. A variety of editing and image processing functions allow you to quickly and easily customize your prints.

1

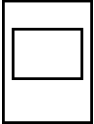

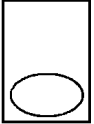

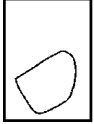

## Main Features

Command sheets allow you to create special effects without cutting and pasting—up to 4 commands can be given for an original. By combining Make-up modes and printing with different color drums, you can create a variety of printing effects.

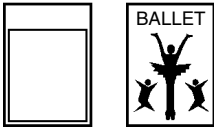
## Make-up Modes for Designated Areas

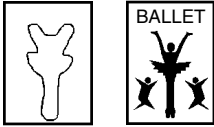

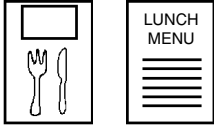
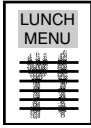
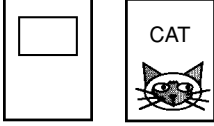



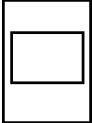

Mode		Sample	
Designated Area		Command sheet/Original (Closed area method)	Print
1.	Letter mode	 	
2.	Photo mode	 	
3.	Delete Area mode	 	
4.	Outline mode	 	

1

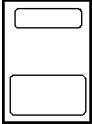
Mode		Sample	
Designated Area		Command sheet/Original (Closed area method)	Print
5.	P./N. mode (Positive Negative mode)		
6.	Solid mode (Image Pattern mode)		
7.	All Page Pattern mode (Area Pattern mode)		
8.	All + Outline (Image Outline and Area Pattern mode)		

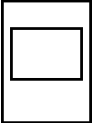

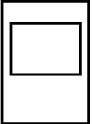
## Make-up Modes for Outside Designated Areas

Mode		Sample	
Undesignated Area		Command sheet/Original	Print
1.	Letter mode: The area outside designated areas is printed in Letter mode.	 	
2.	Photo mode: The area outside designated areas is printed in Photo mode.	 	
3.	Save Area mode: The area outside the designated areas is deleted.	 	
4.	Outline mode: The area outside the designated area is printed in Outline mode.	 	

 **Note**

- In Make-up mode, commands must be given for both designated areas and areas outside the designated areas.

## Background Patterns

A total of 164 background patterns is available in Make-up mode:

- 40 basic patterns
- 40 patterns similar to the basic patterns but with patterns elements at 4 times the size.
- 80 variants based on 90° rotations of all the basic and enlarged patterns.
- 4 registered user patterns.

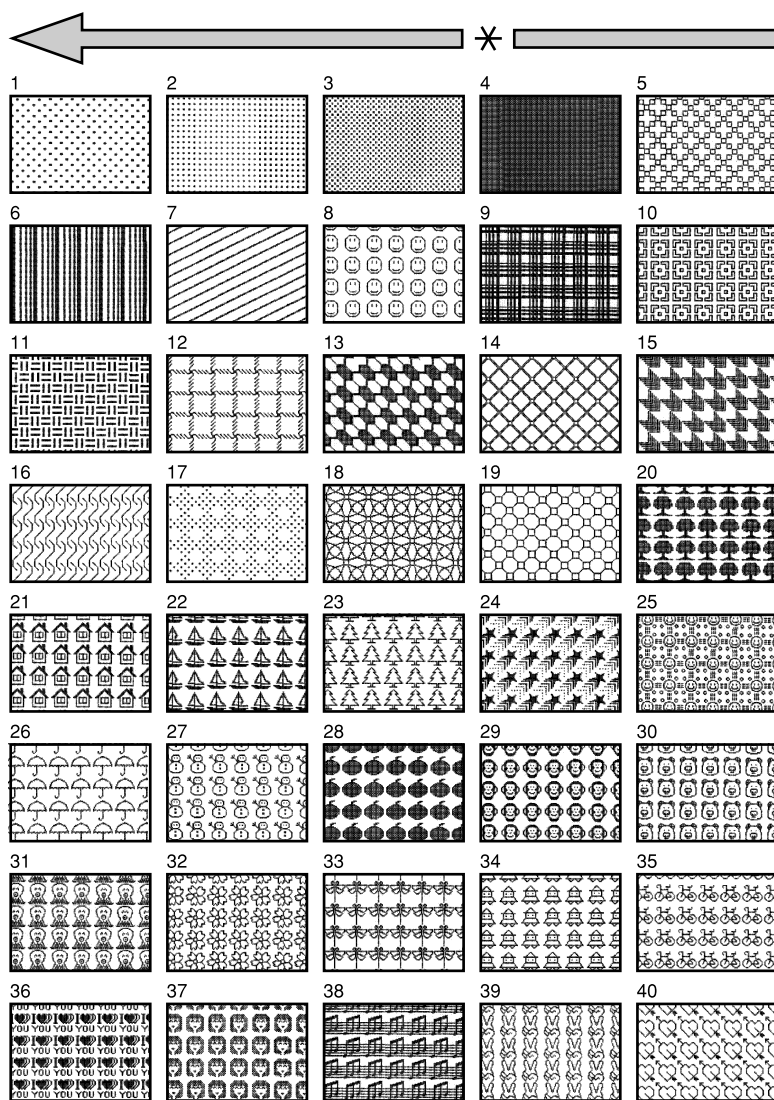

GCM4KE0E

\* Paper Feed Direction

### Note

- The basic patterns are numbered 1 to 40.
- You can make your own make-up background patterns with the user tools. See p.163 “5-11 Make/Chg. Pattern”.

# Command Sheets for Make-Up Printing

Command sheets are fed first so that the machine can recognize the areas of the original which are to be edited as designated areas.

1

## Command Sheets

The command sheet is a sheet of paper designating the areas to be edited. Command sheets must be made on white or translucent paper, and should be the same size as the original.

Do not designate areas within 5 mm, 0.2" from the top.

### Note

- Poor quality paper (such as newsprint, recycled paper, etc.) should not be used for command sheets because any dark spots or streaks will be read as designated areas.
- Do not use blotting paper or other absorbent paper for command sheets because ink might leak through the paper and get the exposure glass dirty.

## Making a Command Sheet

There are two ways of designating areas: the diagonal line method and the closed area method.



### Features

- You can combine up to 4 command sheets when making a master.

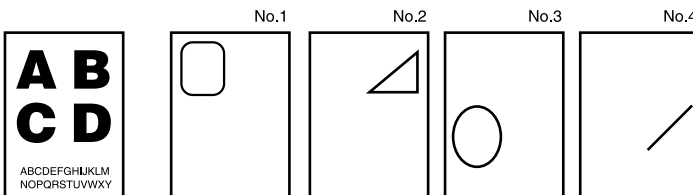

- You cannot use both the closed and diagonal line method on the same command sheet.

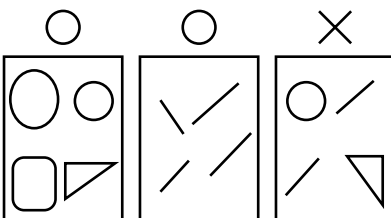

- There is no limit to the number of areas you can designate on a single command sheet.

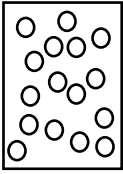

- If designated areas on two or more command sheets overlap, the last command sheet will apply to the overlapping portion.

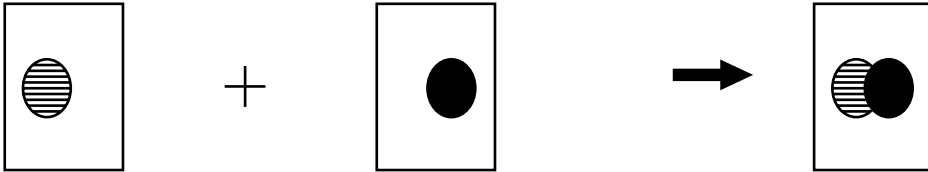



- If you use Outline mode for letter images with a thickness of less than 3mm, 0.12", the print image might come out as expected.

**Notes**

The image might differ depending on how the designated area is drawn, so remember the following when making the command sheet.

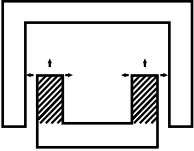
Designated area	Area recognized	Preferred designated area
<p>Part of the designated area is surrounded by 3 sides of the entire area.</p>		<p>Make a space of at least 2mm, 0.08", in front of the area surrounded by 3 sides (relative to the feed direction).</p> <p>1, 2 = 2mm, 0.08"</p>
<p>Double line pattern.</p>	<p>Only the outer line is recognized.</p>	<p>Make a gap of at least 2mm, 0.08" in width.</p>

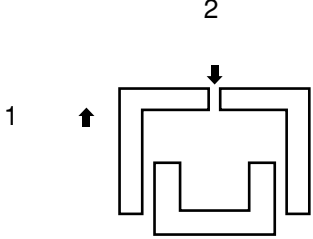
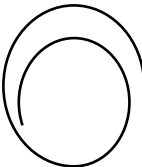
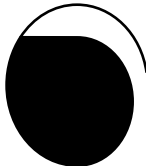
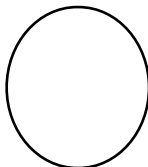
Designated area	Area recognized	Preferred designated area
<p>The designated area is surrounded by 3 sides of another designated area.</p> 		<p>Make a space of at least 2mm, 0.08" in front of the area surrounded by 3 sides (relative to the feeding direction).</p>  <p>1, 2 = 2mm, 0.08"</p>
<p>Non-closed line</p> 		<p>Designate the area with a closed line.</p> 

**Diagonal line method**

 **Note**

A diagonal line must be drawn through the area that you wish to edit.

**1** Put the command sheet on top of the original.

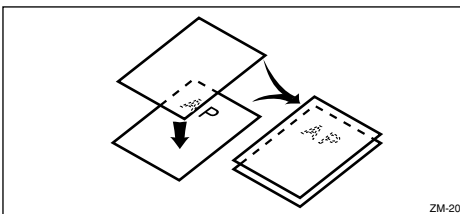

1

**2** Draw a line using a felt tip pen (black, red or blue) with a thickness of at least 1mm.

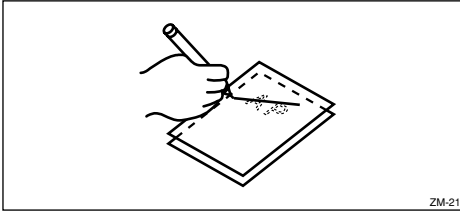

**Note**

- Make sure there is no break in the line.
- The diagonal line can be drawn from left to right or vice versa.
- Draw the line at least 2mm, 0.08", away from the image so that the whole image can be recognized.

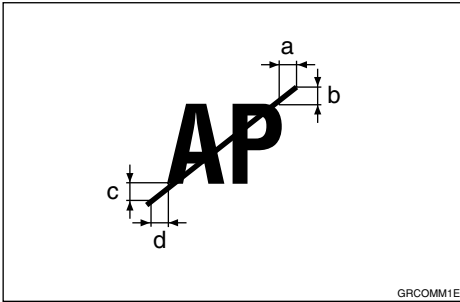

a, b, c, d = 2mm, 0.08"

- The line marking the designated area should be more than 2mm, 0.08", from any neighboring image.

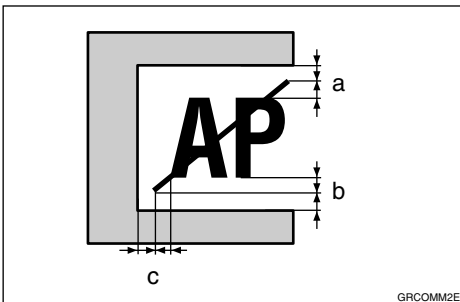

a, b, c = 2mm, 0.08"

## Closed area method

### Note

- The line designating the area must be a closed loop.

**1** Put the command sheet on top of the original.

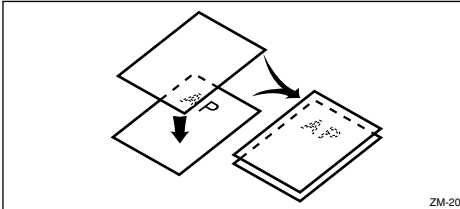

**2** Using a black, red, or blue felt tip pen, draw a line around the area to designate. The line should have a thickness of at least 1mm.

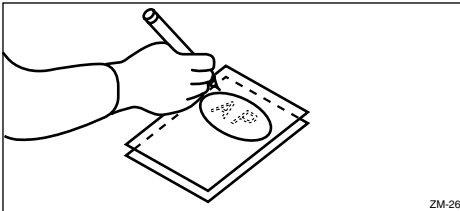

### Note

- Make sure there is no break in the line.
- Draw the line at least 2mm, 0.08", away from the image so that the whole image can be recognized.

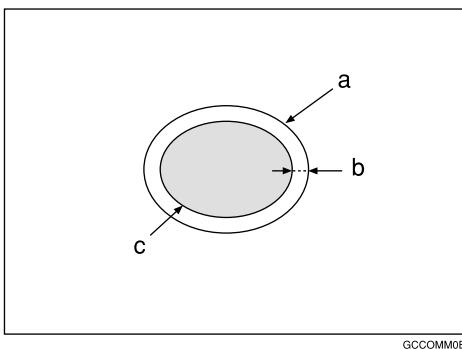

a = Line marking the designated area

b = 2mm, 0.08"

c = Image within the designated area

- ❑ The line marking the designated area should be more than 2mm, 0.08", from any neighboring image.

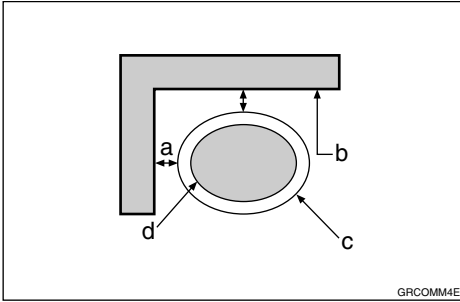

a = 2mm, 0.08"

b = Neighboring image

c = Line marking the designated area

d = Image within the designated area

## Command Sheets and Finished Prints

The following illustrations will help you understand how to draw a command sheet.

### ❖ Drawing a command sheet using a diagonal line

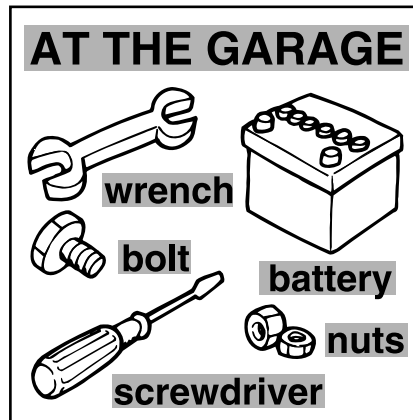
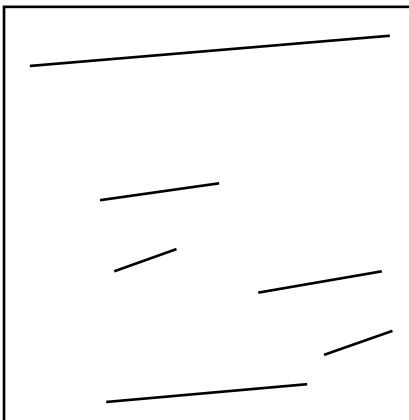

The diagonal line method is easy to use for designating rectangular areas. It is also more precise, but it is difficult to use for designating complex areas.

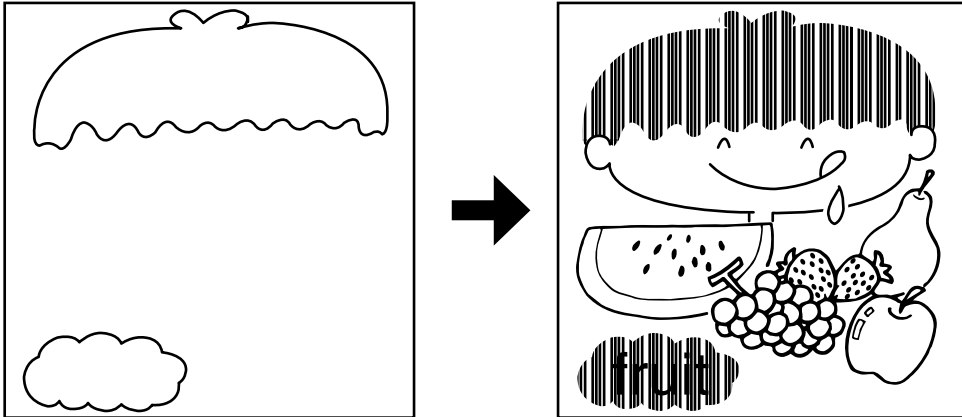

**❖ Drawing a command sheet using a closed line**

The closed line method is easier to use for complex areas, but it is less precise. It also takes longer to draw a command sheet with the closed line method.

# Make-up Printing

1

**1** Press the **[Make-Up]** key.

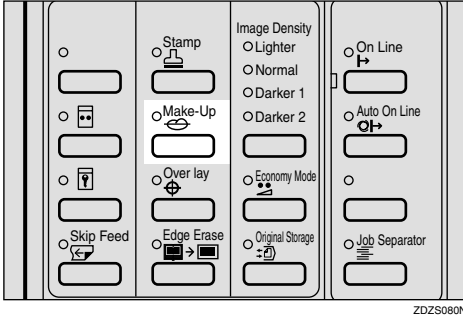

ZDZS080N

**2** Make sure that **[1]** is selected. Then press the **[OK]** key.

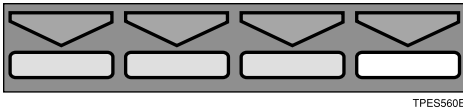
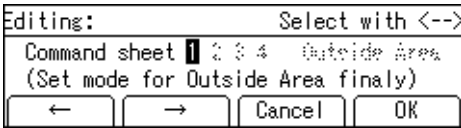

TPES500E

**3** Select the frame shape with the **[←]** **[→]** or **[◀]** **[▶]** keys.

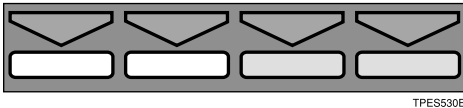
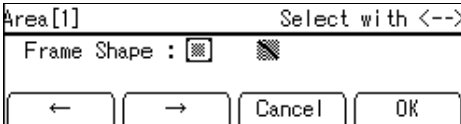

TPES500E

**4** Press the **[OK]** key.

**5** Select the mode for the first command sheet with the **[←]** **[→]** or **[◀]** **[▶]** **[Δ]** **[▽]** keys.

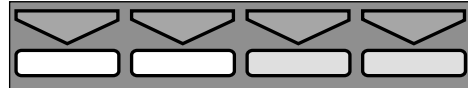
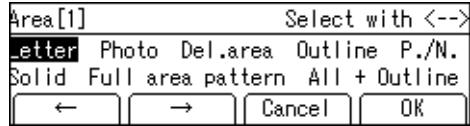

TPES530E

**6** Press the **[OK]** key.

**7** If necessary, select the pattern for the first command sheet with the **[◀]** **[▶]** **[Δ]** or **[▽]** key. Then press the **[OK]** key.

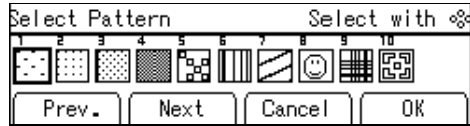

**8** If necessary, select the size and direction of the pattern you selected in step **7** with the **[←]** **[→]** or **[◀]** **[▶]** keys.

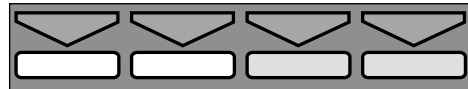
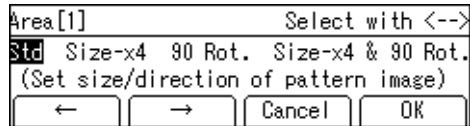

TPES530E

**9** Press the **[OK]** key.

**Note**

- Follow steps **2** – **9** for the other command sheets.
- You can select a pattern registered with the user tools for only one command sheet.

- To change the value entered, press the **[Clear/Stop]** key and enter the new value.

**10** After you have finished designating modes for all the command sheets, select **[Outside Area]** with the **[←]** **[→]** or **[◀]** **[▶]** keys.

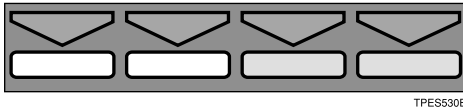
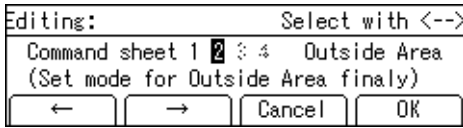

TPES530E

**11** Select the mode for the outside area with the **[←]** **[→]** or **[◀]** **[▶]** keys.

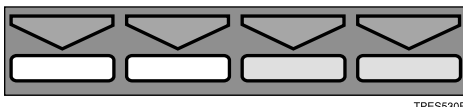
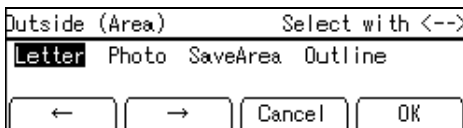

TPES530E

**12** Press the **[OK]** key.

**Note**

- When you select Photo mode for both inside and outside areas, you cannot select different dot patterns and contrast.
- When you want to confirm your settings, press the **[Make-Up]** key twice. Then press the **[OK]** key repeatedly until the panel display reaches the setting you want to confirm.

**13** If you have selected Photo mode, select the dot pattern and the contrast with the **[←]** **[→]** or **[◀]** **[▶]** keys.

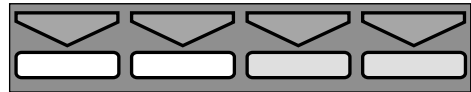
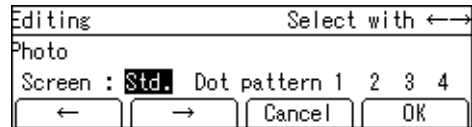

TPES530E

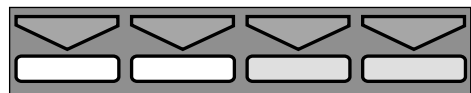
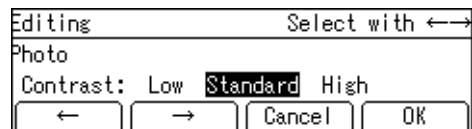

TPES530E

**Note**

- Four dot patterns settings are available:
  - Setting 1: clearest
  - Setting 2: clearer than setting 3
  - Setting 3: clearer than setting 4
  - Setting 4: clearer than the standard setting

**14** Press the **[OK]** key.

- 15** Place the first command sheet face down on the exposure glass and press the **[Start]** key.

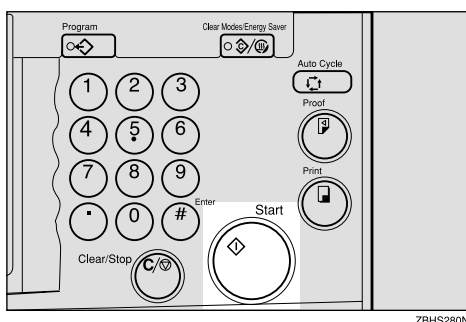

The beeper sounds after the command sheet is scanned.

**Note**

- Repeat step 15 for the other command sheets.

- 16** Place the original face down on the exposure glass or face up into the document feeder and press the **[Start]** key.

**Note**

- If a command sheet or original misfeeds from the document feeder, remove the misfed sheet or original and reset it in the document feeder.
- It is not necessary to reset the previous command sheets or original.

# Make-up Samples

1

## Sample 1

- ① Command Sheet No. 1, Frame shape  $\square$ , Designated area: Delete Area mode
- ② Outside area: Letter mode
- ③ Print

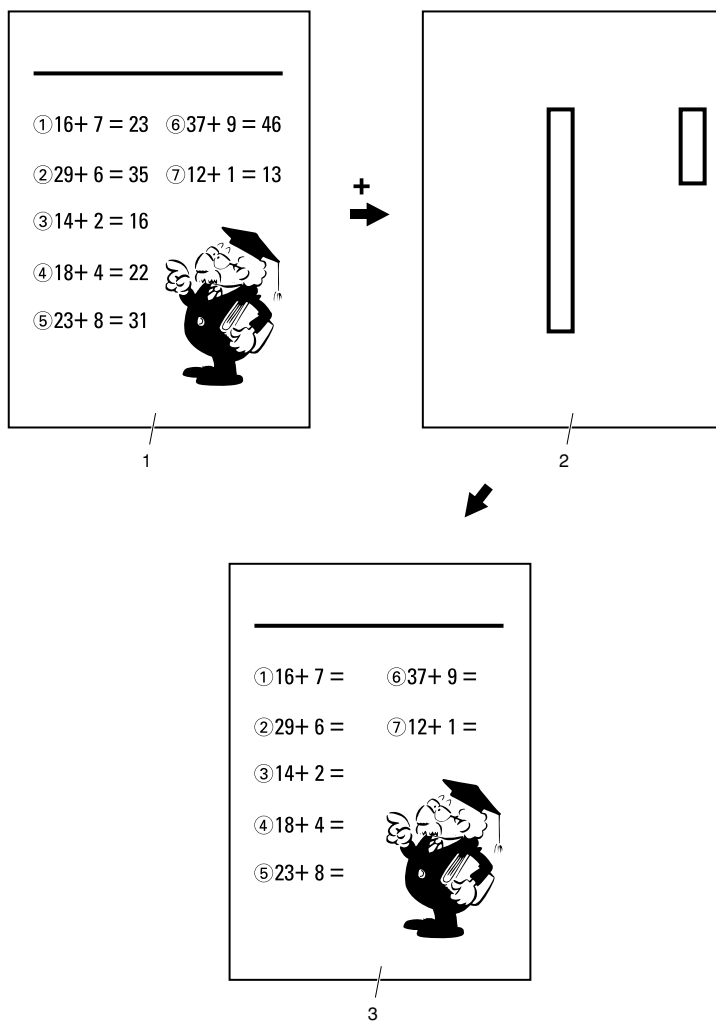

1. Original

3. Print

2. Command sheet No.1

ZM-50

**Sample 2**

- ① Command Sheet No. 1, Frame shape /, Designated area: All + Outline No. 30
- ② Command Sheet No. 2 Frame shape □, Designated area: All page pattern No. 17
- ③ Outside area: Fn1
- ④ Print

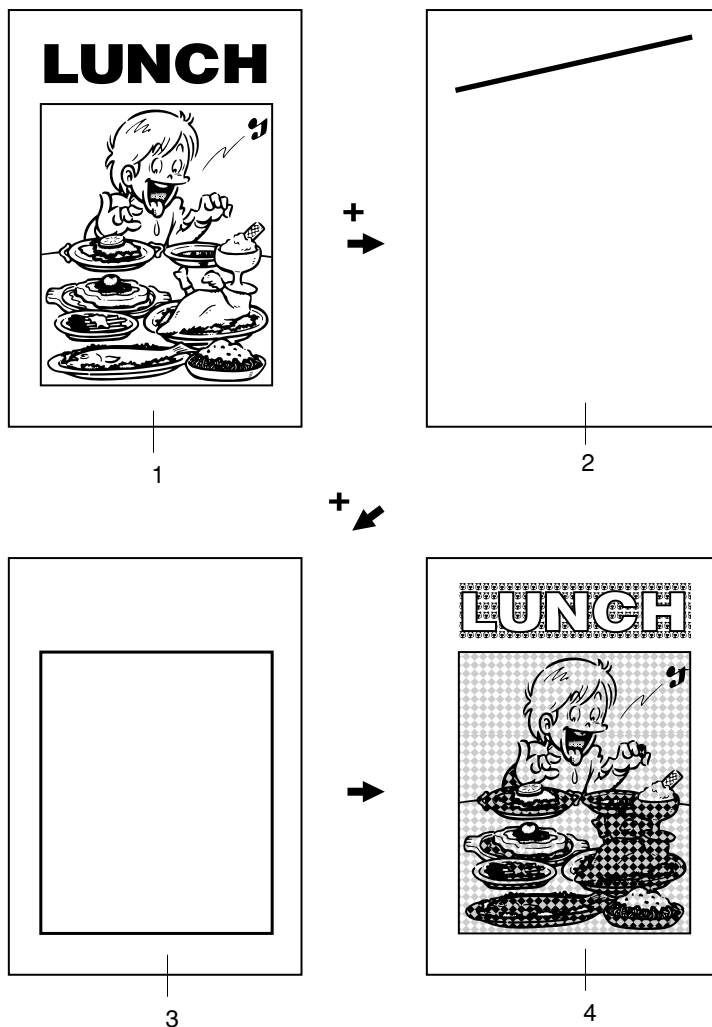

ZM-51

1. Original

2. Command sheet No.1

3. Command sheet No.2

4. Print

**Sample 3**

- ① Print the original as it is
- ② Change the drum unit for color printing
- ③ Command Sheet No. 1, Frame shape , Designated area: All page pattern No. 39
- ④ Outside area: Letter mode
- ⑤ Print

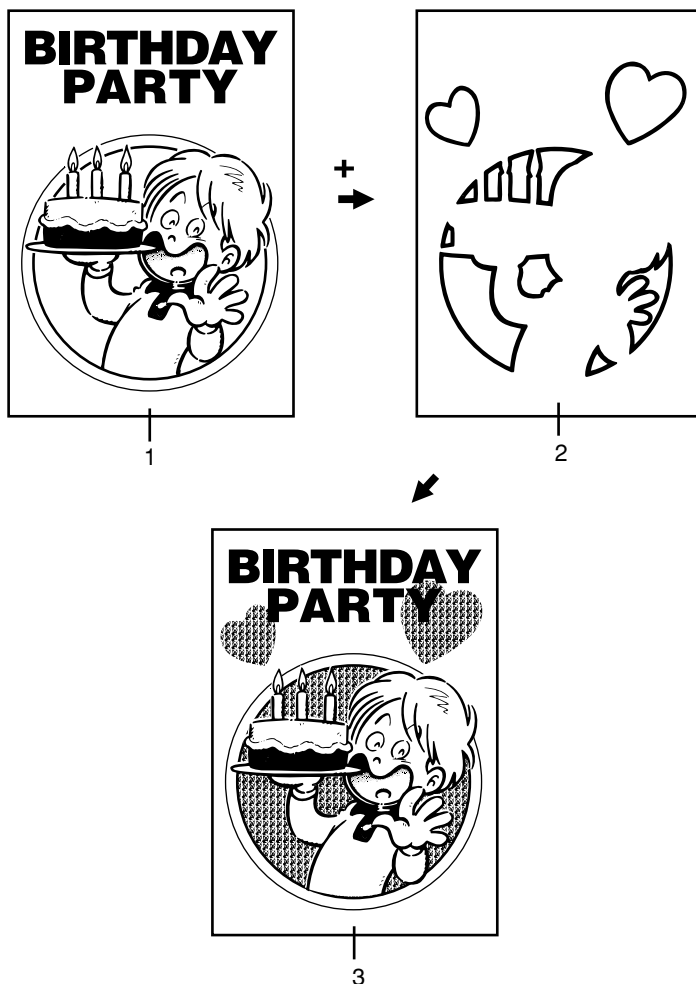

**1. Original**

**3. Print**

**2. Command sheet No.1**

ZM-52

# Original Storage

1

You can store frequently used originals in machine memory and then easily recall them later to make prints whenever they are needed.

## Preparation

- You can store up to 8 Original Storage settings in machine memory.
- The number of Original Storage settings you can store depends on the type of originals.
- You may not be able to store Original Storage settings for some types of original.
- The machine remembers Original Storage settings even after the power to the machine has been switched off or the **【Clear Modes/Energy Saver】** key has been pressed to clear.

**1** Press the **【Original Storage】** key.

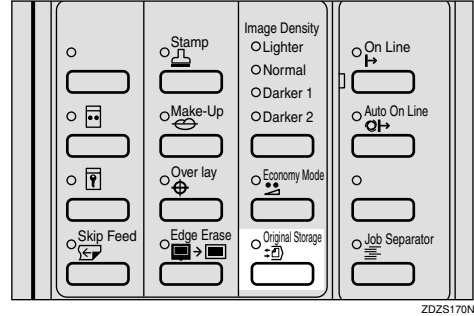

**2** Select **【Store】** with the **【→】** or **【▷】** key.



**3** Press the **【OK】** key.

**4** Select the desired number to store with the **【←】****【→】** or **【◀】****【▶】** keys.

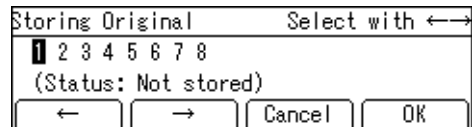

## Storing Originals

Store the print images of the originals you want to use frequently.

### Note

- ☐ You can use this feature with:
  - Reproduction Ratio
  - Selecting Original Modes
  - Adjusting the Image Density of Prints
  - Edge Erase



- 5** Place the original on the exposure glass as shown, then press the **[Start]** key.

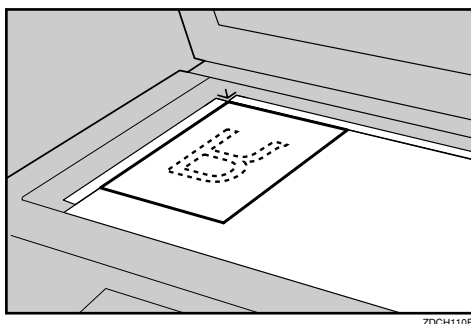

ZDCH110E

**Note**

- If print images for an original have already been stored in machine memory, check the stored images and choose whether to overwrite them or not. To overwrite the images, press the **[Yes]** key. To keep the images, press the **[No]** key.

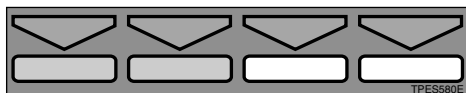
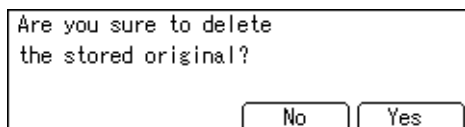

TPES580E

- If you select overwrite, the document stored in memory will be erased unless it is write protected.

## Non-standard size originals

- 1** If you place non-standard size original, this display will be shown.

Press the **[OK]** key.

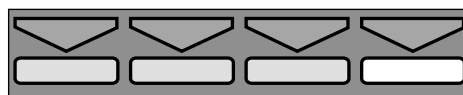
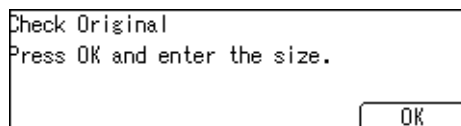

TPES560E

- 2** Enter the vertical length with the number key, and then press the **[#]** key.

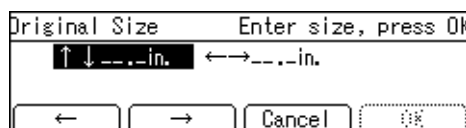

- 3** Enter the horizontal width with the number key, and then press the **[#]** key.

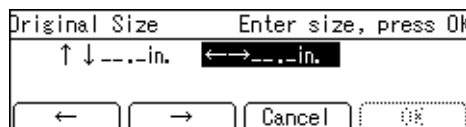

- 4** Place your originals on the exposure glass, and then press the **[Start]** key.

## Selecting Stored Originals

To select the images of originals that have been stored in machine memory, do the following:

**1** Press the **[Original Storage]** key.

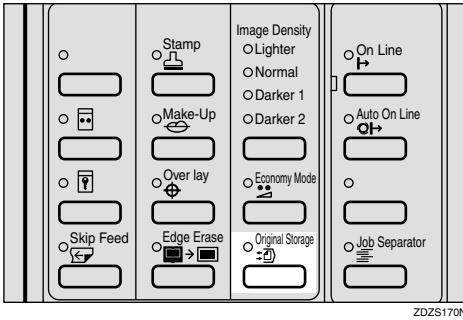

**2** Select **[Select]** with the **[←][→]** or **[◀][▶]** keys.

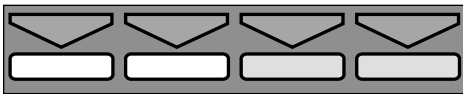
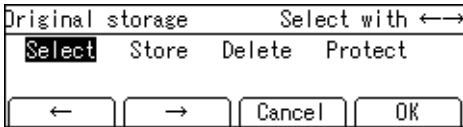

**3** Press the **[OK]** key.

**4** Select the number of the stored original with the **[←][→]** or **[◀][▶]** keys.

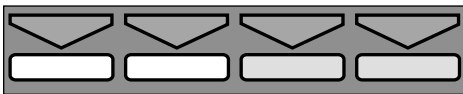
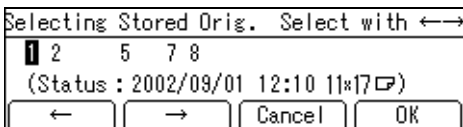

**5** Press the **[OK]** key.

**6** Press the **[Start]** key.

## Protecting Stored Originals

If you want to protect the images of originals stored in machine memory, do the following:

### Protecting Originals

**1** Press the **[Original Storage]** key.

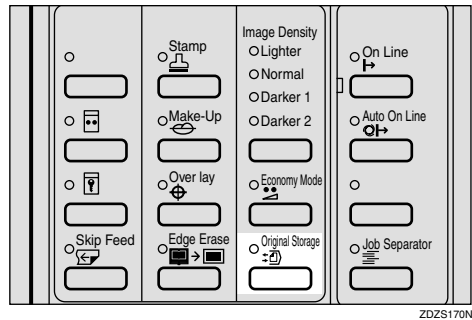

**2** Select **[Protect]** with the **[→]** or **[▶]** key.

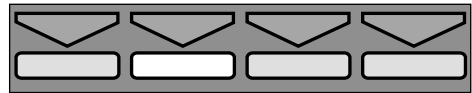

**3** Press the **[OK]** key.

**4** Select the number of the original to be protected with the **[←][→]** or **[◀][▶]** keys.

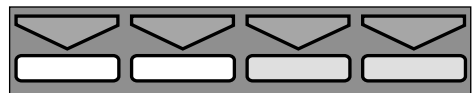
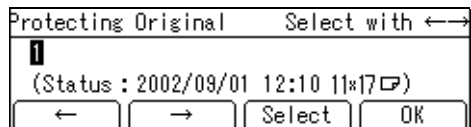

**5** Press the **[Select]** key.

- 6** Press the [OK] key.

## Removing Original Protection

- 1** Press the [Original Storage] key.

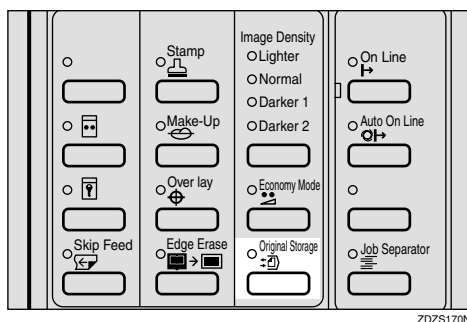

ZDZS170N

- 2** Select [Protect] with the [→] or [▷] key.

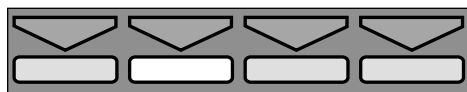
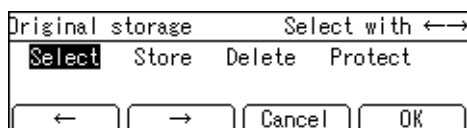

TPES570E

- 3** Press the [OK] key.

- 4** Press the [Cancel] key.

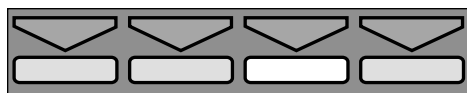
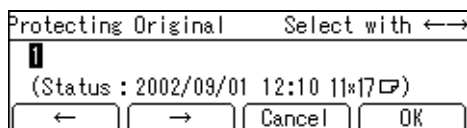

TPES520E

## Deleting Stored Originals

If you want to delete the images of originals stored in machine memory, do the following:

### Important

- You cannot restore the images once they have been deleted.

- 1** Press the [Original Storage] key.

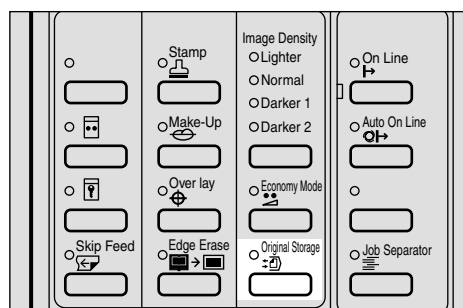

ZDZS170N

- 2** Select [Delete] with the [→] or [▷] key.

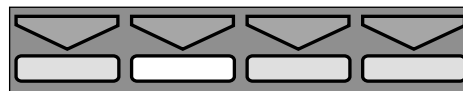
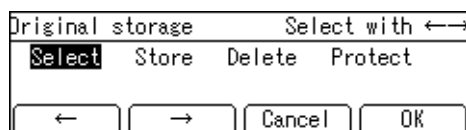

TPES570E

- 3** Select the number of the original to be deleted with the [←][→] or [◀][▶] keys.

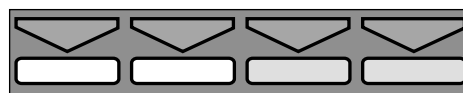
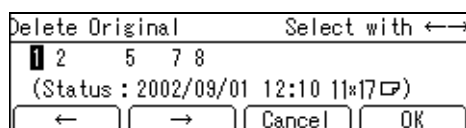

TPES530E

**4** Select the [Yes] or [No] key.

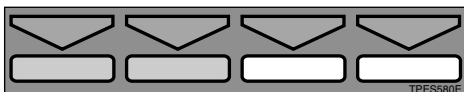
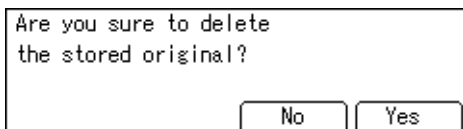

 **Note**

- Press the **[No]** key if you do not wish to delete the Stored Original.

# Image Overlay

The machine can merge two different originals onto the same print paper.

Two types of merging are available:

## ❖ Overlay

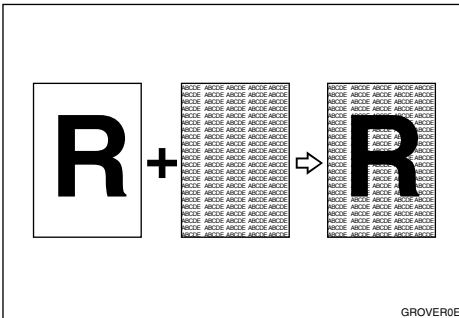

Two different originals are merged onto the same print paper.

## ❖ Format

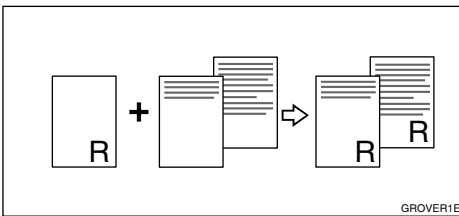

The image of the original which is copied first will become the background image for all copies. The following originals will be copied with this background.

## ❖ On Line overlay

When your machine is equipped with the optional PC controller, an image sent from a PC and the original image can be merged onto the same print paper.

## ❖ Storage overlay

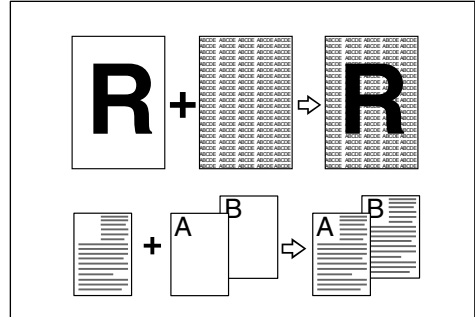

Combines the images of originals stored in Original Storage with the originals placed on the machine.

## Storage Overlay

### 1 Press the [Overlay] key.

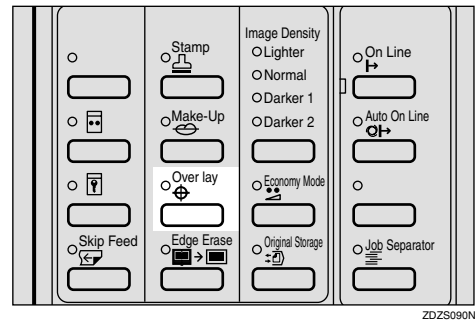

### 2 Select [Storage overlay] with the [←][→] or [◀][▶] keys.

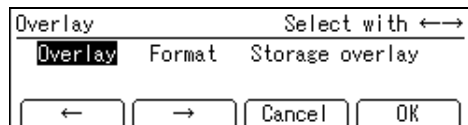

**3** Press the [OK] key.

**Note**

- If the one of the stored originals already chosen, the display in step **3** does not show. Skip to step **4**.

**4** Press the [OK] key.

**5** Place your originals, and then press the [Start] key.

**3** Place you originals and print start with your PC.

**Limitation**

- The optional PC controller is required to use On Line Overlay mode.
- In order to get a correct print image, the size of the original and the PC image should be identical.

## On Line Overlay

**1** Press the [On Line] key.

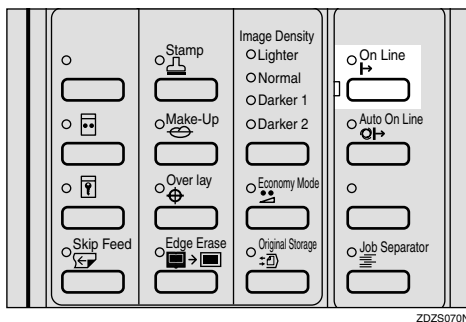

ZDZS070N

**2** Press the [Overlay] key.

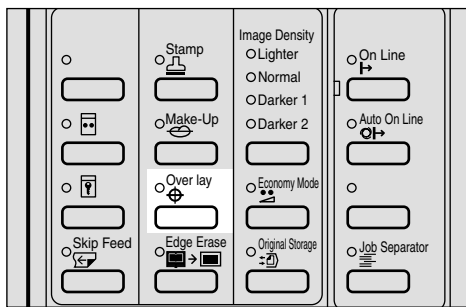

ZDZS090N

## Overlay Format

**1** Press the [Overlay] key.

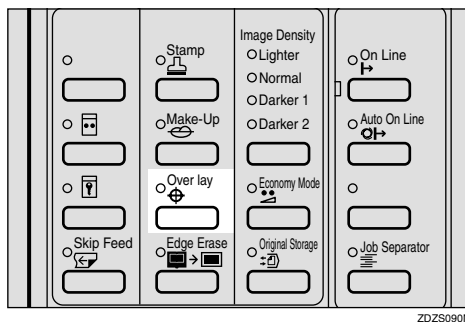

ZDZS090N

**2** Select one of Image Overlay modes with the [←] [→] or [◀] [▶] keys.

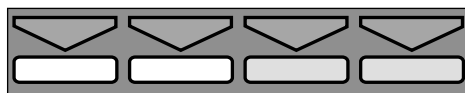
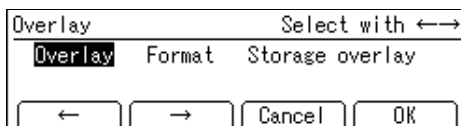

TPES530E

**3** Press the [OK] key.

**4** Place your originals, and then press the [Start] key.

## Placing originals on the exposure glass

- 1 Place the first original on the exposure glass.

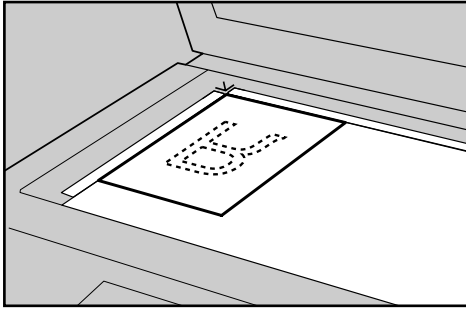

- 2 Press the **[Start]** key.

### Note

- When you select **[Format]** in step 2, the original for the template should be placed first.
- To change the background image in Format mode, press the **[#]** key. Then place the next original for the template and press the **[Start]** key.

- 3 Place the next original on the exposure glass.

- 4 Press the **[Start]** key.

### Note

- When you select **[Format]** in step 2, repeat steps 3 and 4.

## Placing originals in the optional document feeder

- 1 Place originals in the document feeder.

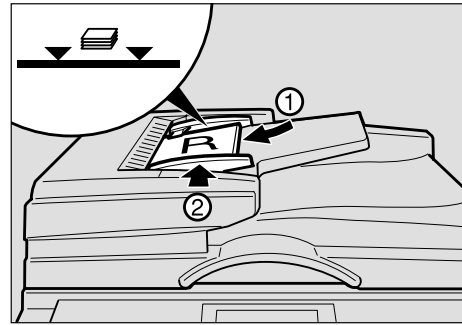

### Note

- To avoid originals misfeeding, fan the originals before placing them in the document feeder.

- 2 Press the **[Start]** key.

### Note

- When you select **[Format]** in step 2, the original for the template should be on the top.
- To change the background image in Format mode, press the **[#]** key. Then set the next original for the template and press the **[Start]** key.

# Date Stamp

1

Use this function to have the date stamped on prints.

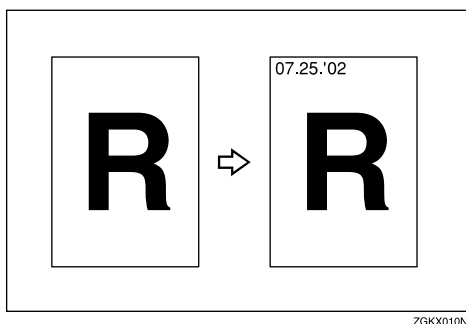

## Preparation

Before you use this function, you have to set the machine's internal clock with the user tools. See p.153 "1-6 Time Setting".

## Limitation

- The font size of the date cannot be changed.
- If you select Page Stamp and Date Stamp together, the last stamp direction selected takes priority.

## Note

- The default format of Date Stamp is "Month Day Year". You can change this setting with the user tools. See "Date Style Set" on p.148 "5. Stamp".
- You can edit the Date Stamp position. See p.160 "5-7 Position (Date)".
- The Date Stamp directions on the panel display and actual print images are as follows.

Date Stamp direction on the display	Print image		

## 1 Press the [Stamp] key.

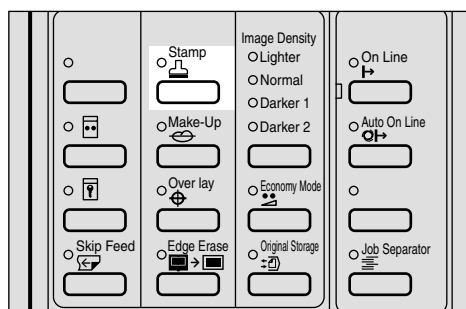

ZDZS100N



- 2** Make sure that [Date] is selected.

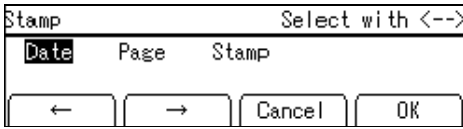

- 3** Press the [OK] key.

- 4** Select the desired position and direction with the [←][→] or [◀]{▶} keys.

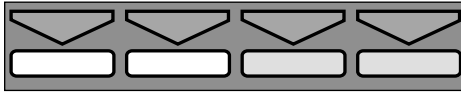
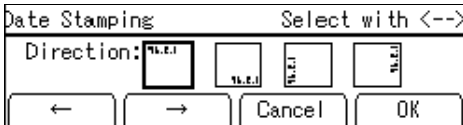

TPES330E

- 5** Press the [OK] key.

- 6** Select the [Yes] or [No] key.

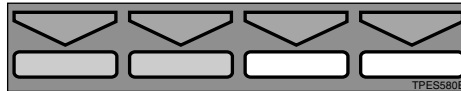
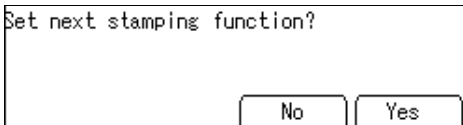

TPES580E

**Note**

- Press the [Yes] key if you wish to set the other Stamp functions.

- 7** Place your original, and then press the [Start] key.

Placing your original (□) on the exposure glass

- 1** Place your original as shown in the illustration.

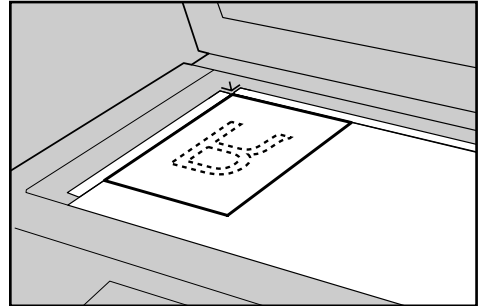

ZDCH110E

Placing your originals (□) in the optional document feeder

- 1** Place your originals as shown in the illustration.

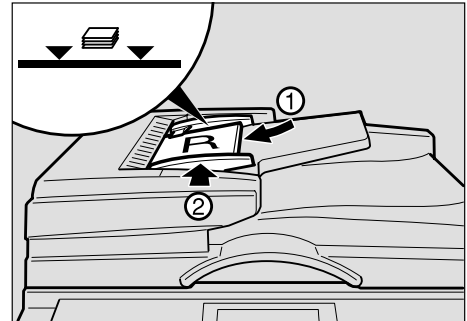

ZDCH120E

**Note**

- To avoid originals misfeeding, fan the originals before placing them in the document feeder.

# Page Stamp

1

Use this function to have page numbers stamped on prints.

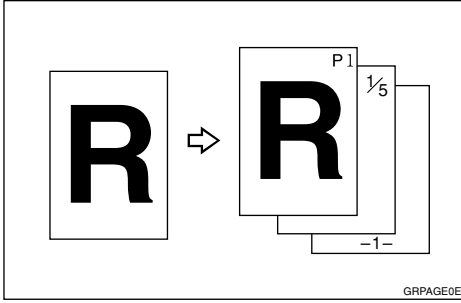

Three numbering formats are available:

- P1, P2,....., P5
- 1/5, 2/5,....., 5/5
- -1-, -2-,....., -3-

**Limitation**

- ❑ The size and font of Page Stamp cannot be changed.
- ❑ If you select Page Stamp and Date Stamp together, the last stamp direction selected takes priority.

**Note**

- ❑ Check the following table for the relationship between the Page Stamp direction on the panel display and the actual print image.

PageStamp direction on the display	Print image

- ❑ You can edit the preset page numbering position with the user tools. See p.161 “5-10 Position (Page)”.
- ❑ [P1, P2,...., P5] is the default format. You can change this default setting with the user tools. See “Type(Page)” on p.148 “5. Stamp”.

**1** Press the **[Stamp]** key.

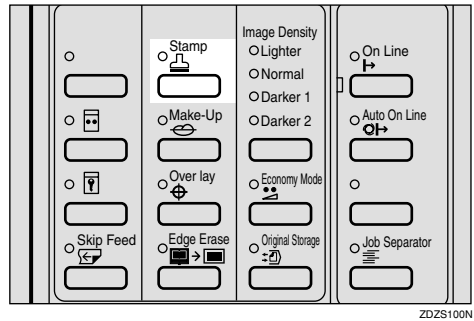

**2** Select **[Page]** with the **[→]** or **[▷]** key.

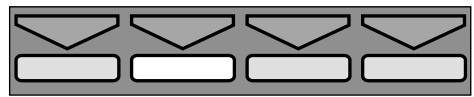
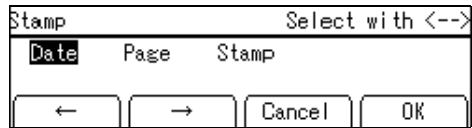

**3** Press the **[OK]** key.

**4** Select the desired format with the **[←]** **[→]** or **[◀]** **[▶]** keys.

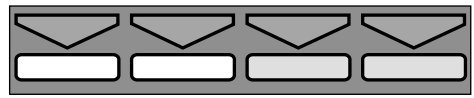
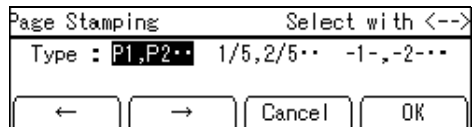

## 5 Press the [OK] key.

If you selected [P1,P2] or [-1,-2-]

### 1 Enter the first page number with the [←][→] or [◀][▶] keys.

Page Stamping		Select with <-->	
First Page : 1 (Set the init. page number to print)			
←	→	Cancel	OK

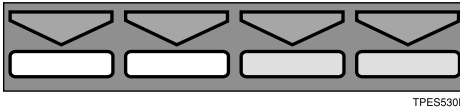

#### Note

- You can also enter the page number with the number keys.
- To change the value entered, press the **[Clear/Stop]** key and enter the new value.

### 2 Press the [OK] key.

If you selected [1/5,2/5]

### 1 Enter the last page number with the [←][→] or [◀][▶] keys.

Page Stamping		Select with <-->	
Last Page : --5 (Set number of originals to print)			
←	→	Cancel	OK

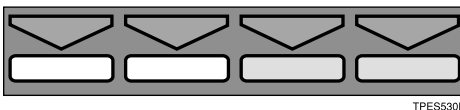

#### Note

- You can also enter the page number with the number keys.
- To change the value entered, press the **[Clear/Stop]** key and enter the new value.

### 2 Press the [OK] key.

### 3 Enter the first page number with the [←][→] or [◀][▶] keys.

Page Stamping		Select with <-->	
First Page : 1 (Set the init. page number to print)			
←	→	Cancel	OK

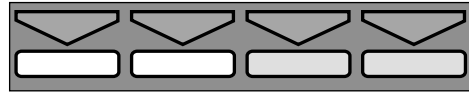

#### Note

- You can also enter the page number with the number keys.
- To change the value entered, press the **[Clear/Stop]** key and enter the new value.

### 4 Press the [OK] key.

### 6 Select the desired orientation with the [←][→] or [◀][▶] keys.

Page Stamping		Select with <-->	
Direction: <input type="checkbox"/> P1 <input type="checkbox"/> 2			
←	→	Cancel	OK

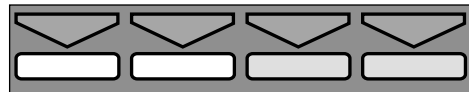

### 7 Press the [OK] key.

### 8 Select the [Yes] or [No] key.

Set next stamping function?	
No	Yes

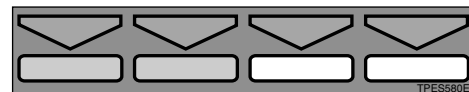

#### Note

- Press the **[Yes]** key if you wish to set the other Stamp modes.

### 9 Place your original, and then press the [Start] key.

1

Placing your originals (📄) on the exposure glass

- 1 Place the first original as shown in the illustration.

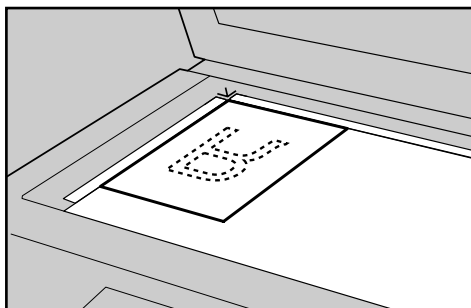

ZDCH110E

 **Note**

- ☐ Repeat step 1 for the other originals.

Placing your originals (📄) in the optional document feeder

- 1 Place your originals as shown in the illustration.

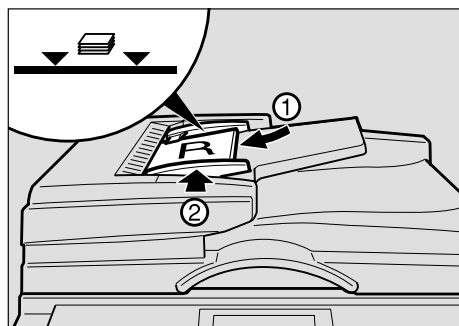

ZDCH120E

 **Note**

- ☐ The first original should be on the top.
- ☐ To avoid originals misfeeding, fan the originals before placing them in the document feeder.

# Stamp

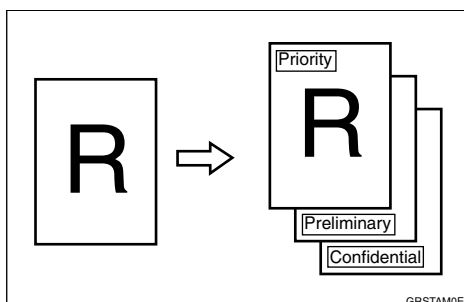

One of the following 3 messages can be stamped on prints.

CONFIDENTIAL

PRIORITY

PRELIMINARY

## ! Limitation

- Only one message can be stamped at a time.

## 📝 Note

- You can change some Stamp settings (size, density, or position) with the user tools. See "Size", "Stamp Density", "Stamp Position" on p.148 "5. Stamp".
- The message "CONFIDENTIAL" is selected as a default. You can change this setting with the user tools. See "Type" on p.148 "5. Stamp".

## 1 Press the [Stamp] key.

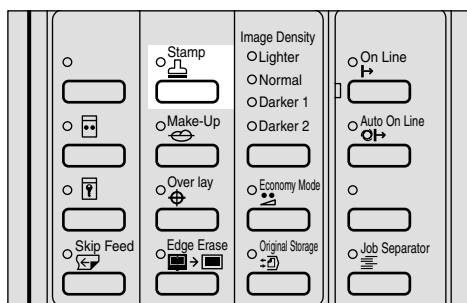

## 2 Select [Stamp] with the [←] [→] or [◀] [▶] keys.

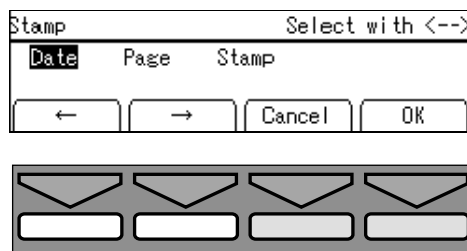

## 3 Press the [OK] key.

## 4 Select the desired message with the [←] [→] or [◀] [▶] keys.

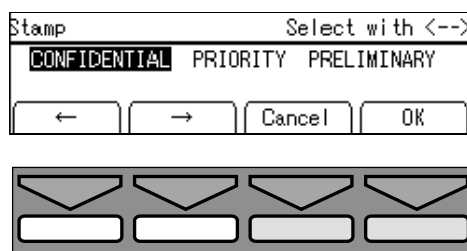

## 5 Press the [OK] key.

## 6 Select the page to be stamped with the [←] [→] or [◀] [▶] keys.

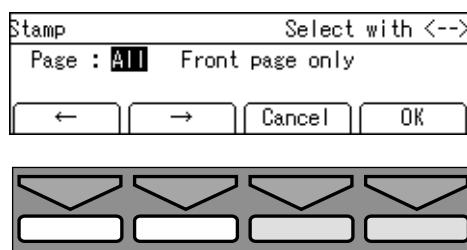

## 7 Press the [OK] key.

1

**8** Select the stamp position with the [←] [→] or [◀] [▶] keys.

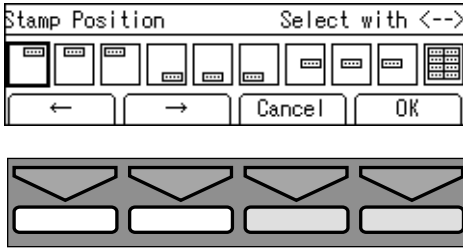

TPES530E

**9** Press the [OK] key.

**10** Select the [Yes] or [No] key.

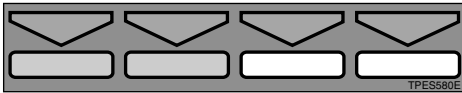
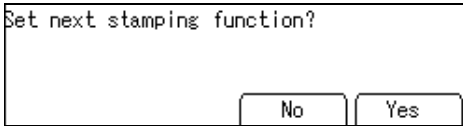

TPES580E

**Note**

Press the [Yes] key if you wish to set the other Stamp modes.

**11** Place your original and press the [Start] key.

Placing your original (☐) on the exposure glass (contact glass)

**1** Set your original as shown in the illustration.

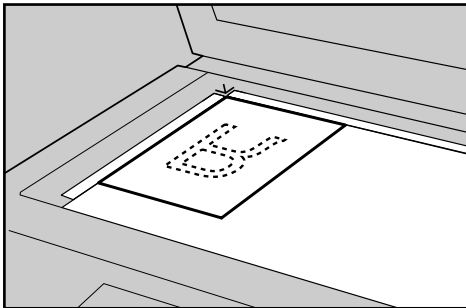

ZDCH110E

Placing your originals (☐) in the optional document feeder

**1** Place your originals as shown in the illustration.

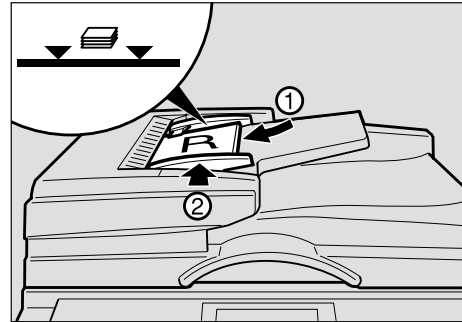

ZDCH120E

**Note**

To avoid originals misfeeding, fan the originals before placing them in the document feeder.

# Memory Combine

You can combine originals in four ways:

❖ **4 single-sided originals → 1 single-sided print of 4 images**

4 one-sided pages are printed onto 1 one-sided sheet, 4 original images on one side.

❖ **8 single-sided originals → 1 single-sided print of 8 images**

8 one-sided pages are printed onto 1 one-sided sheet, 8 original images on one side.

❖ **16 single-sided originals → 1 single-sided print of 16 images**

16 one-sided pages are printed onto 1 one-sided sheet, 16 original images on one side.

❖ **Repeating an image over the entire print**

1 original image is printed repeatedly.

 **Note**

- A separation line between images can be printed with the user tools. See “Comb. Sep. Line” on p.144 “4. Mode Setting”.

---

## Combining onto a Single-sided Print

---

❖ **4 single-sided originals → 1 single-sided print of 4 images**

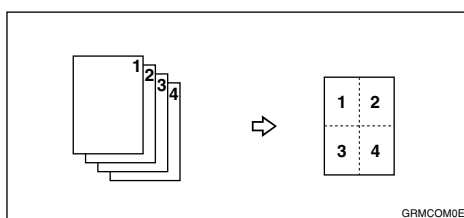

### ◆ 8 single-sided originals → 1 single-sided print of 8 images

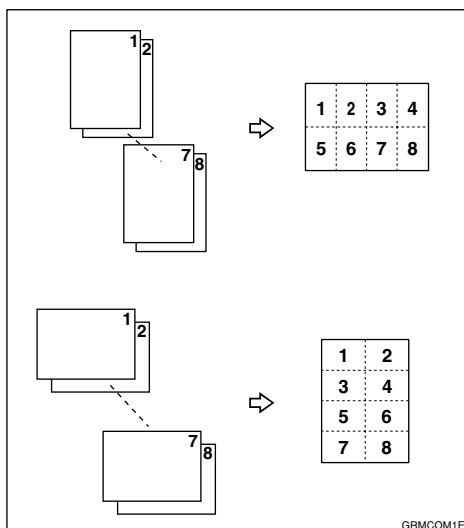

### ◆ 16 single-sided originals → 1 single-sided print of 16 images

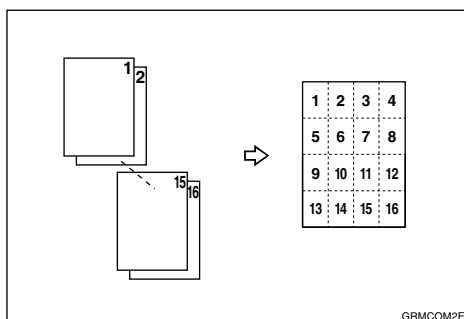

#### ! Limitation

- To use “16 one-sided originals → 1 one-sided print of 16 images” mode, the optional document feeder is required.
- If the calculated ratio is under the minimum ratio, it is corrected within the range of the ratio automatically. However, with some ratios, parts of the image might not be copied.
- The machine cannot copy originals different in size and direction.

#### ✎ Note

- The number of originals printed (combined) can be 4, 8, or 16.
- In this mode, the machine selects the reproduction ratio automatically. This reproduction ratio depends on the print paper size and the number of originals.
- When the original is placed at a different direction from the print paper, the machine automatically rotates the original image by 90° to match the print paper direction.



- You can set the machine to cancel Memory Combine mode after finishing your print job with the user tools. See “Cancel Comb.” on p.144 “4. Mode Setting”.
- Refer to the following table when you select the original and paper sizes.

#### ◆ Placing originals in the optional document feeder (metric version)

Original	A3	B4	A4	B5	A5
Paper					
A3	*3	*3	*2	*2	*1
B4	--	*3	*3	*2	*2
A4	--	--	*3	*3	*2
B5	--	--	--	*3	*3

\*1 You can use these original and paper sizes in Combine 4, 8, 16 Originals mode.

\*2 You can use these original and paper sizes in Combine 4, 8 Originals mode.

\*3 You can use these original and paper sizes in Combine 4 Originals mode.

#### ◆ Placing originals in the optional document feeder (inch version)

Original	11" × 17"	8 <sup>1</sup> / <sub>2</sub> " × 14"	8 <sup>1</sup> / <sub>2</sub> " × 11"	8 <sup>1</sup> / <sub>2</sub> " × 5 <sup>1</sup> / <sub>2</sub> "
Paper				
11" × 17"	*3	*3	*2	*1
8 <sup>1</sup> / <sub>2</sub> " × 14"	--	*3	*3	*2
8 <sup>1</sup> / <sub>2</sub> " × 11"	--	--	*3	*2
5 <sup>1</sup> / <sub>2</sub> " × 8 <sup>1</sup> / <sub>2</sub> "	--	--	--	*3

\*1 You can use these original and paper sizes in Combine 4, 8, 16 Originals mode.

\*2 You can use these original and paper sizes in Combine 4, 8 Originals mode.

\*3 You can use these original and paper sizes in Combine 4 Originals mode.

#### ◆ Placing originals on the exposure glass (metric version)











Original	A3	B4	A4	B5
Paper				
A3	*2	*2	*1	*1
B4	--	*2	*2	*1
A4	--	--	*2	*2
B5	--	--	--	*2

\*1 You can use these original and paper sizes in Combine 4, 8 Originals mode.

\*2 You can use these original and paper sizes in Combine 4 Originals mode.

1

❖ **Placing originals on the exposure glass (inch version)**

Original	11" × 17" 	8 1/2" × 14" 	8 1/2" × 11"  
Paper			
11" × 17" 	*2	*2	*1
8 1/2" × 14" 	--	*2	*2
8 1/2" × 11"  	--	--	*2
5 1/2" × 8 1/2"  	--	--	--

\*1 You can use these original and paper sizes in Combine 4, 8 Originals mode.

\*2 You can use these original and paper sizes in Combine 4 Originals mode.

**1** Press the **[Combine]** key.

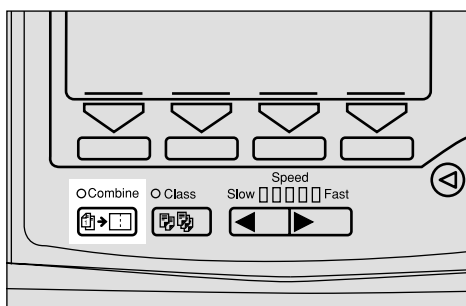

ZBHS510N

**2** Select **[Memory Combine]** with the **[→]** or **[▷]** key.

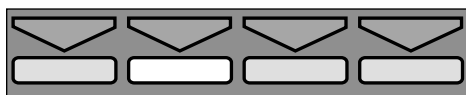
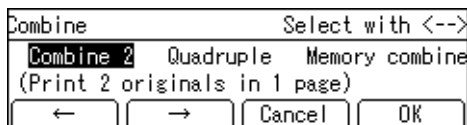

TPES570E

**3** Press the **[OK]** key.

**4** Select your desired mode.

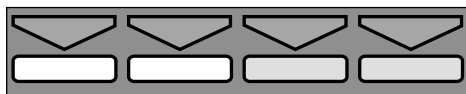
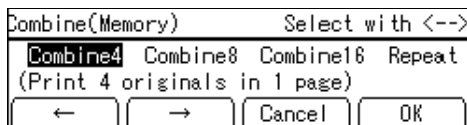

TPES530E

**5** Press the **[OK]** key.

**6** Place your originals.

---

Placing your original (  ) on the exposure glass

---

**1** Place your original as shown in the illustration.

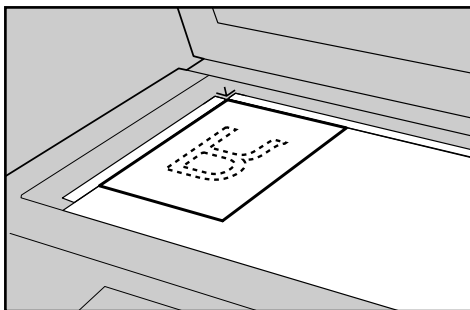

ZDCH110E

---

Placing your originals (  ) in the optional document feeder

---

**1** Place your originals as shown in the illustration.

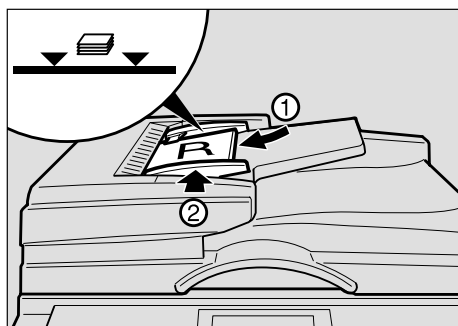

ZDCH120E

**Note**

- The first original should be on the top.
- To avoid originals misfeeding, fan the originals before placing them in the document feeder.

**7** Press the **[Start]** key.

**Note**

- ❑ Even if the number of originals is less than the number required in the selected mode, prints can be made as shown in the illustration. In this case, press the **[#]** key after all the originals have been scanned.

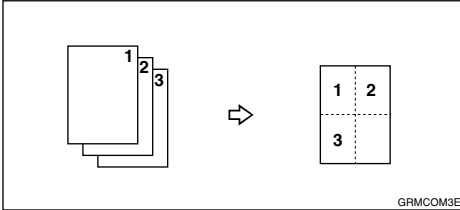

- ❑ When placing an original on the exposure glass or one sheet at a time in the optional document feeder, repeat steps **6** and **7**. After placing the last original, press the **[#]** key, and then the **[Start]** key.

---

## Repeat

---

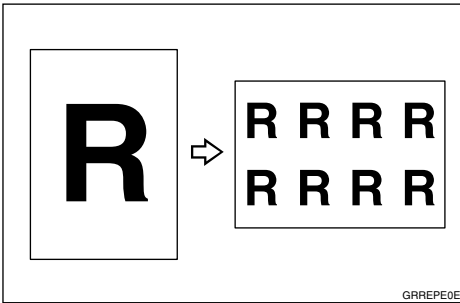

**Limitation**

- ❑ Part of the repeated image might not be printed depending on the paper size, direction and reproduction ratio.

**Note**

- ❑ The number of repeated images depends on the original and paper size, and reproduction ratio.

- ☐ Check the following table for the relationship between the direction of the original and paper, and the number of repeated images.

❖ Example: copying A4 ☐ originals onto A3 ☐ paper.

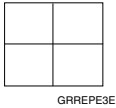
The number of repeated images	Reproduction ratio	Print image
4	71%	

❖ Example: copying A5 ☐ originals placed in the optional document feeder onto A3 ☐ paper.

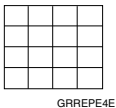
Number of repeated images	Reproduction ratio	Print image
16	50%	

❖ Example: copying  $8\frac{1}{2}$ "  $\times$  11" ☐ originals onto 11"  $\times$  17" ☐ paper.

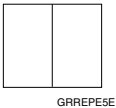
Number of repeated images	Reproduction ratio	Print image
2	100%	

❖ Example: copying A5 ☐ originals placed in the optional document feeder onto A4 ☐ paper.

Number of repeated images	Reproduction ratio	Print image
8	50%	

**1** Press the **[Combine]** key.

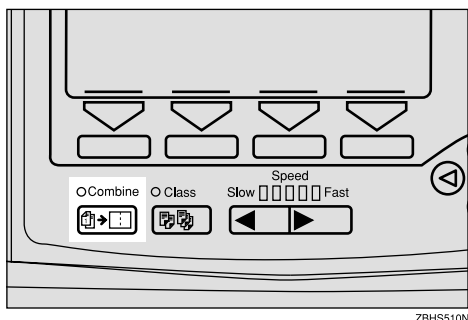

**2** Select **[Memory Combine]** with the **[→]** or **[▷]** key.

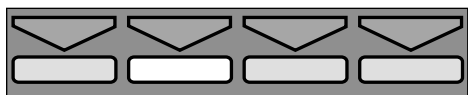
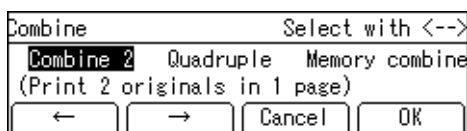

TPES570E

**3** Press the **[OK]** key.

**4** Select **[Repeat]** with the **[→]** or **[▷]** key.

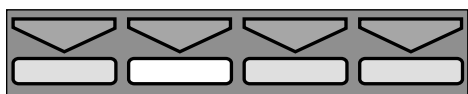
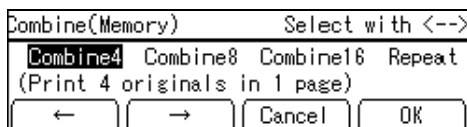

TPES570E

**5** Press the **[OK]** key.

**6** Select the reproduction ratio.

 **Reference**

See p.29 "Reducing and Enlarging Using Preset Ratios".

**7** Set your original.

---

## Placing your original (📄) on the exposure glass

---

- 1 Place your original as shown in the illustration.

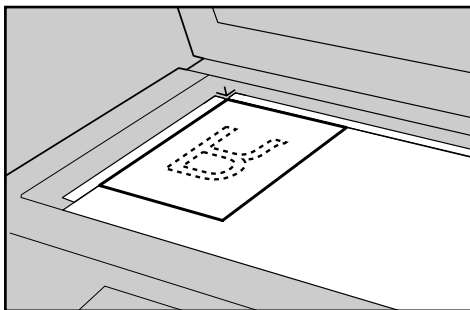

ZDCH110E

---

## Placing your originals (📄) in the optional document feeder

---

- 1 Place your originals as shown in the illustration.

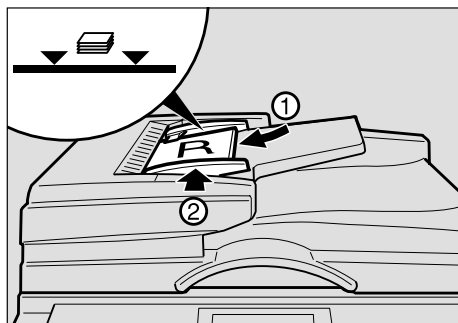

ZDCH120E

 **Note**

- ❑ To avoid originals misfeeding, fan the originals before placing them in the document feeder.

- 8 Press the **[Start]** key.





# 2. Optional Functions

## Optional Document Feeder

Insert a stack of originals in the document feeder. It will be fed automatically.









### Originals

Placing the following originals in the document feeder might cause misfeeds or damage to the originals.

Place the following kinds of originals on the exposure glass:

- Originals heavier than 128g/m<sup>2</sup>, 34 lb
- Originals lighter than 52g/m<sup>2</sup>, 14 lb
- Originals smaller than 148mm × 210mm, 5.9" × 8.3"
- Originals larger than 297mm × 864mm, 11.6" × 34.0"
- Stapled or clipped originals
- Perforated or torn originals
- Curled, folded, or creased originals
- Originals with any kind of coating, such as thermal fax paper, art paper, aluminum foil, carbon paper, or conductive paper
- Bound originals such as books
- Damaged originals
- Originals with glue on them
- Pasted originals
- Originals written in pencil
- Thin originals that are a little stiff
- Originals with index tabs
- Transparent originals such as OHP transparencies or translucent paper

The following original sizes placed in the document feeder can be detected.

Metric version	A3  , B4  , A4  , B5  , A5 
Inch version	11" × 17"  , 8 1/2" × 14"  , 8 1/2" × 11"  , 5 1/2" × 8 1/2" 

### Reference

For the original sizes placed on the exposure glass can be detected, see p.13 "Originals".

### Note

- Place originals after correction fluid and ink have completely dried. Not taking this precaution could mark the exposure glass and cause marks to be printed.

For standard printing functions, set originals as shown below.

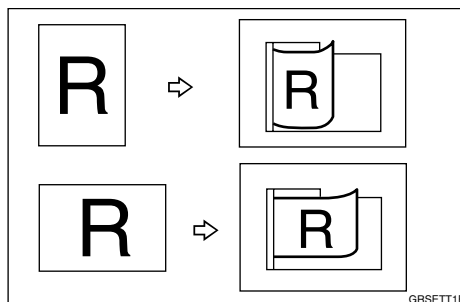

If the original is placed in a different direction from the print paper, the machine automatically rotates the original image by 90° to match the print paper direction.

You cannot place originals of different sizes at the same time.

When you use thin originals, place one original at a time in the document feeder or place them on the exposure glass.

The first 8mm, 0.32", of the leading edge and the last 2mm, 0.08" of the trailing edge cannot be printed. Make sure the leading edge margin is at least 8mm, 0.32", and the trailing edge margin is at least 2mm, 0.08".

Do not stack originals above the limit mark.

2

## Placing Originals

**1** Adjust the guide to the original size.

**2** Insert the aligned originals face up into the document feeder.

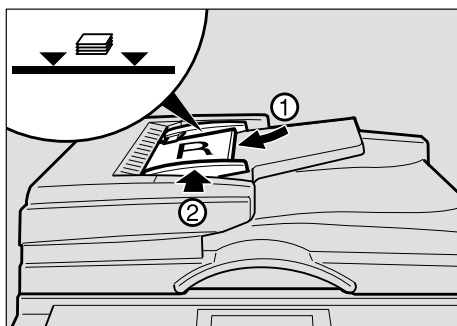

### Note

- ❑ To avoid originals misfeeding, fan the originals before placing them in the document feeder.

### Limitation

- ❑ Approximately 50 originals (80g/m<sup>2</sup>, 21 lb) can be inserted at one time in the document feeder. The first (top) original will be fed first.

### Note

- ❑ To avoid jamming, fan the originals before placing them in the document feeder.
- ❑ The guides must fit snugly against both sides of the stack.

**3** Adjust print settings as necessary, and then press the **[Start]** key.

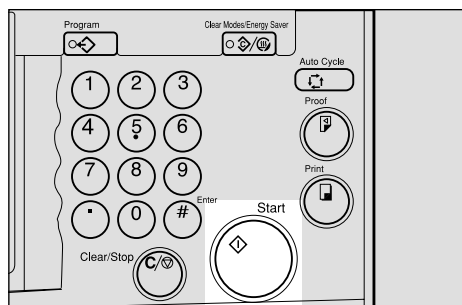

**4** Make your prints.

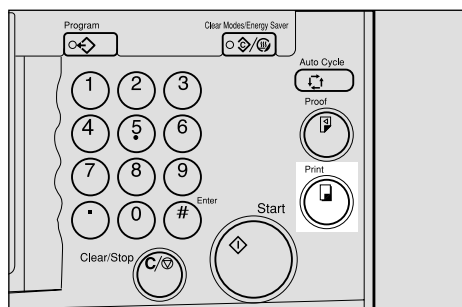

### Note

- ❑ If the next original has been placed in the document feeder before the machine stops, that original is fed automatically and a trial print is delivered to the paper delivery tray after the print of the first original is completed. Check the image position on the trial print of the next original. If necessary, make proof prints using the **[Proof]** key to check the image position again.

## Combine Printing

### Reference

See p.63 “Combine Originals” for details.

### 1 Insert the two originals face up.

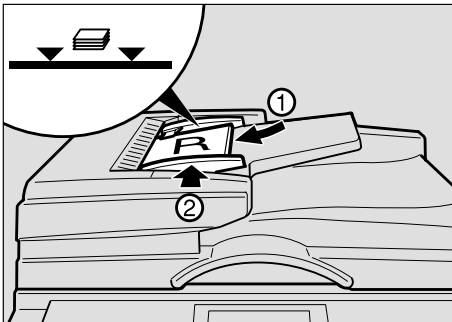

ZDCH120E

### Note

- The first original will be printed on the left side of the paper.
- To avoid originals misfeeding, fan the originals before placing them in the document feeder.

### 2 Enter the number of prints with the number keys.

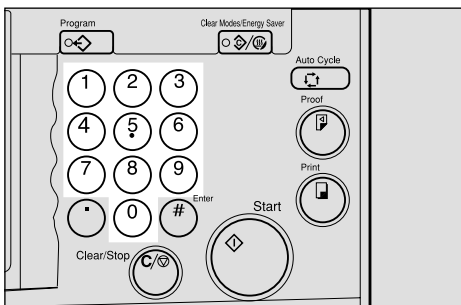

ZBHS310N

### 3 Check the print paper size and the reproduction ratio.

### Note

- To have the machine choose a suitable ratio automatically, use Auto Magnification mode. See p.31 “Auto Magnification”.

### 4 Press the [Combine] key.

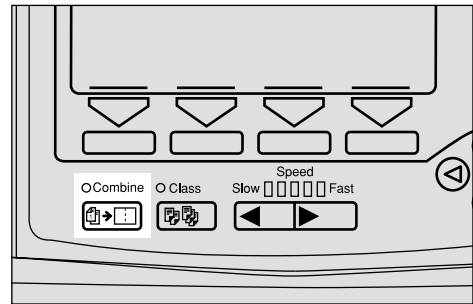

ZBHS510N

### 5 Select [Combine 2] or [Quadruple] with the [←][→] or [◀][▶] keys.

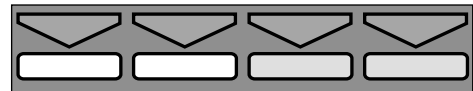
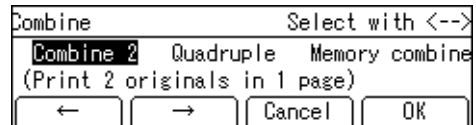

TPES530E

### 6 Press the [OK] key.

### 7 Press the [Start] key.

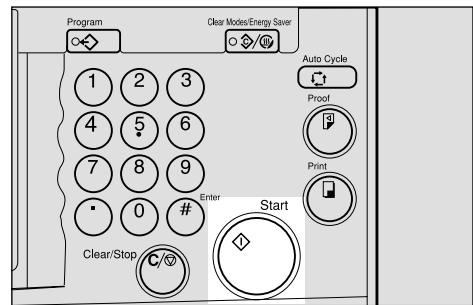

ZBHS280N

### 8 Check the image position on the trial or proof print.

### Note

- If the image position is not correct, adjust it using the [Image ⚙️] key. See p.24 “Adjusting the Position of Printed Images”.
- After the first original has been stored, the second original is fed.

- ❑ If you place only one original, the beeper sounds after the first original has been scanned in. Place the second original and any print settings you require. Then press the **[Start]** key.

2

## Manual Class Mode with Two or More Originals

### Reference

See p.59 “Manual Class Mode with two or More Originals”.

- 1 Press the **[Class]** key.

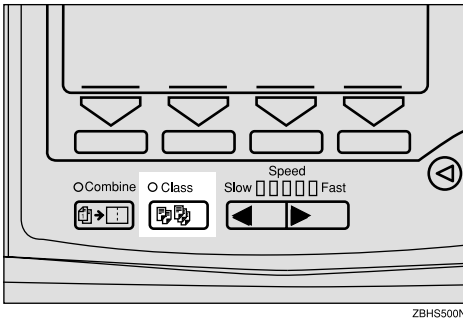

- 2 Select **[Manual]** with the **[→]** or **[▷]** key.

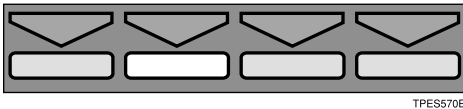
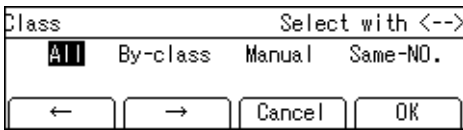

- 3 Press the **[OK]** key.

- 4 Enter the desired number of prints for the first original with the number keys.

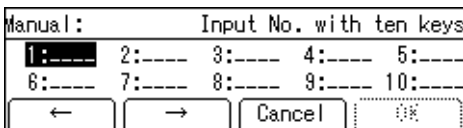

- 5 Press the **[#]** key.

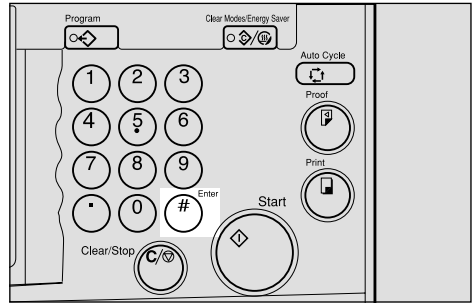

- 6 Enter the desired number of prints for the second original with the number keys.

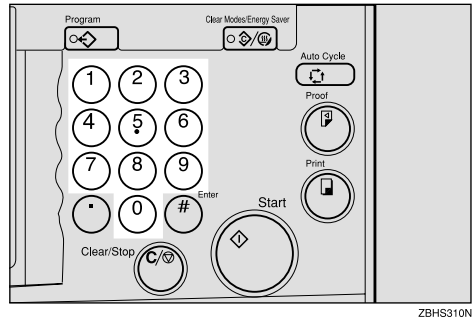

- 7 Press the **[#]** key.

### Note

- ❑ Repeat steps 6 and 7 for each original.
- ❑ Up to 20 classes can be set.

- 8 Press the **[OK]** key.

- 9 Place your originals face up in the document feeder.

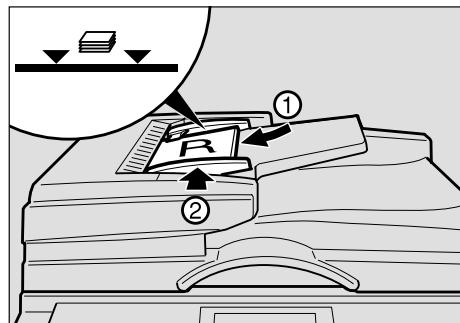

ZDCH120E

**Note**

- To avoid originals misfeeding, fan the originals before placing them in the document feeder.
- The originals are fed from the top of the stack. Make sure that the originals are placed in the correct sequence with the first on the top.

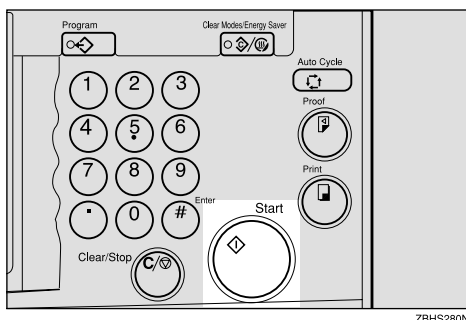
**10** Press the **[Start]** key.**11** Check the image position on the trial or proof print.**Note**

- If the image position is not correct, adjust it using the **[Image ❄️]** key. See p.24 "Adjusting the Position of Printed Images".

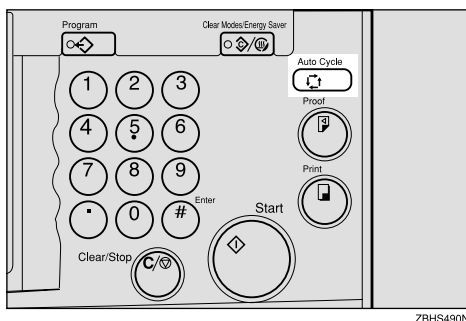
**12** Press the **[Auto Cycle]** key.**Note**

- In Auto Cycle mode, printing starts automatically after a trial print is delivered.

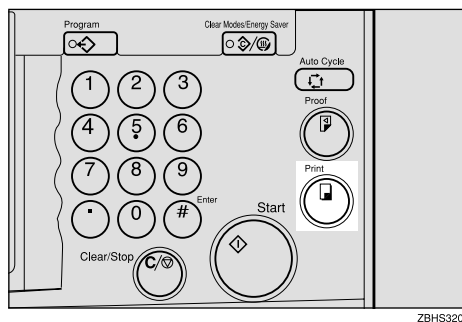
**13** Press the **[Print]** key.

# Color Printing Using the Optional Color Drum

Color drum units are available as options in addition to the standard black unit. For making color prints, a separate drum unit is necessary for each color.

## Note

- ❑ If the ink on the color drum dries, use the Quality Start mode. See p.76 "Quality Start Mode".

## Making Color Prints

- 1 Make sure that the color drum indicator is lit.

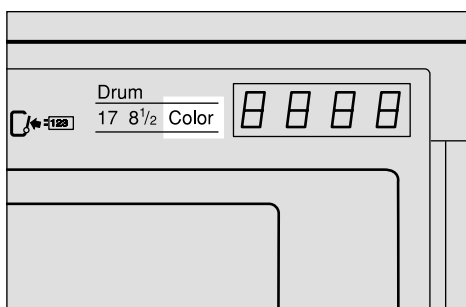

- 2 Press the **[Start]** key.
- 3 Check the image position on the trial or proof print.

## Note

- ❑ If the image position is not correct, adjust it using the **[Image ⚙️]** key. See p.24 "Adjusting the Position of Printed Images".

- 4 Make your prints.

## Changing the Color Drum Unit

- 1 Open the front door.
- 2 Lower the drum unit lock lever (B1).

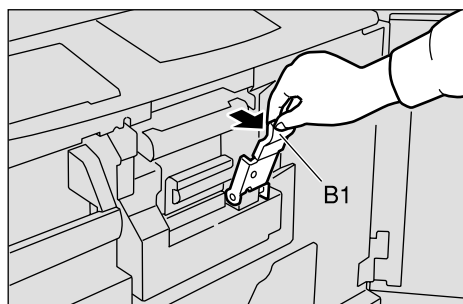

## Note

- ❑ Make sure the green light beside the drum unit lock lever is on before sliding out the drum. If the light is off, close the front door, wait for five seconds, and then open.

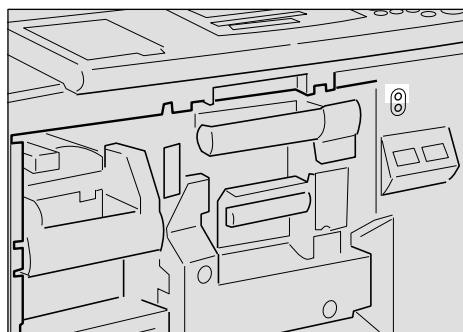

- 3** Pull the drum unit handle out slowly (B2).

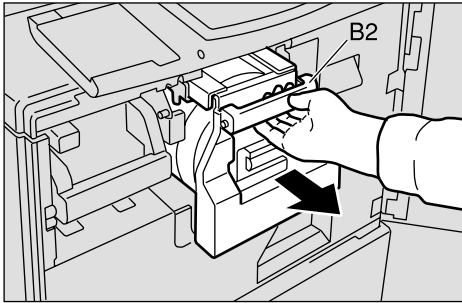

- 4** Lift the upper drum stay (B3) a little to unlock the drum unit, and then pull out the drum unit while holding the drum unit handle (B2) and the upper drum stay (B3).

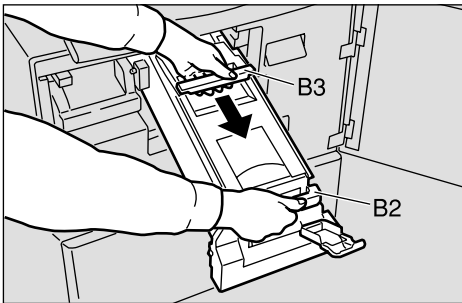

**Important**

- Be careful not to let the drum unit fall.

- 5** Make sure the optional color drum lock is securely set.

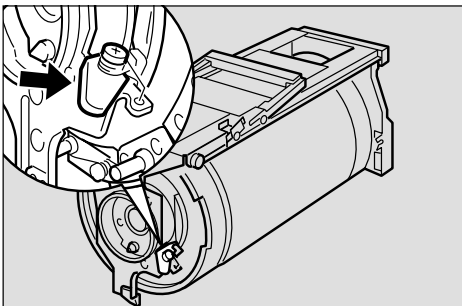

- 6** Insert the color drum unit along the guide rail.

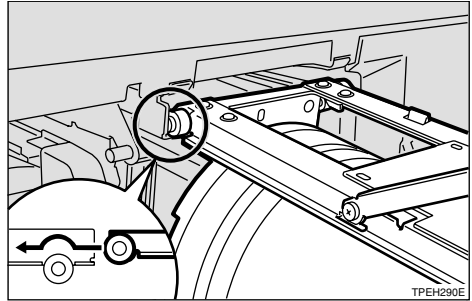

- 7** Lower the drum unit lock lever (B1) of the inserted drum.

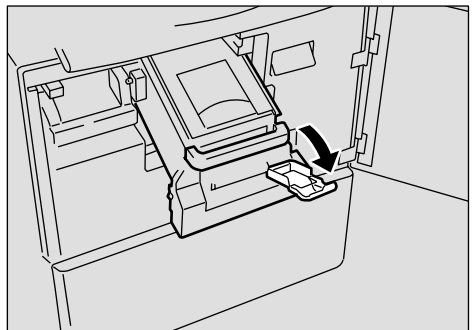

- 8** Slide in the drum unit until it locks in position.

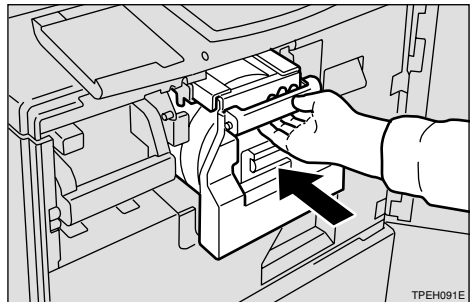

**9** Lift drum unit lock lever (B1).

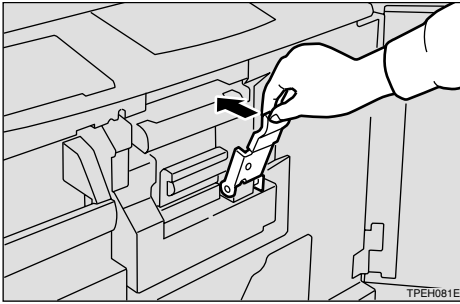

**10** Close the front door.

**Note**

- Make sure that the **Open Cover/Unit** indicator turns off, and the **Color Drum** indicator turns on.

## Printing in Two Colors

After printing in one color, you can print in another color on the same side of the print.

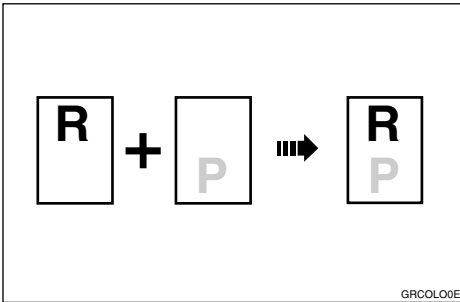

**Note**

- Let the ink on the prints dry for a while before printing on them again.
- If the prints are not dry, the paper feed roller might become dirty. In this case, wipe the roller with a cloth.
- You cannot print in two colors at one time.

**1** Prepare the two originals. Place the first original on the exposure glass.

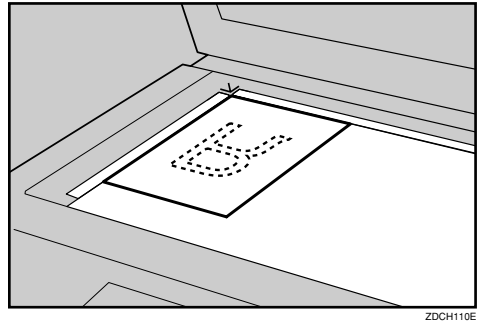

**2** Enter the number of prints with the number keys.

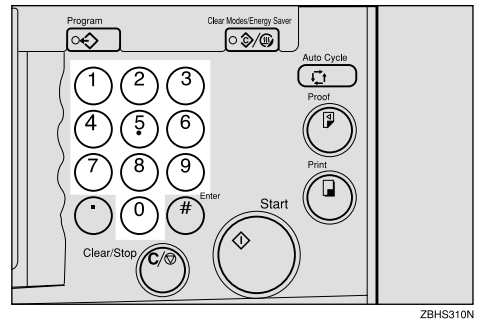

**3** Press the **[Start]** key.

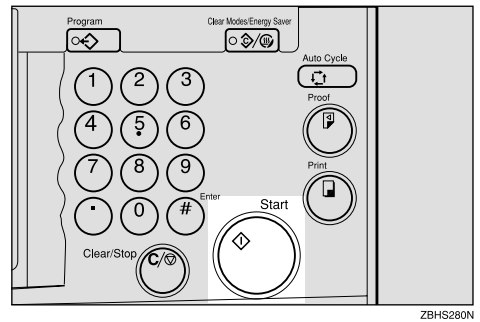

**4** Check the image position on the trial or proof print.

**Note**

- If the image position is not correct, adjust it using the **[Image ⚙️]** key. See p.24 "Adjusting the Position of Printed Images".



- 5** Press the **[Print]** key.

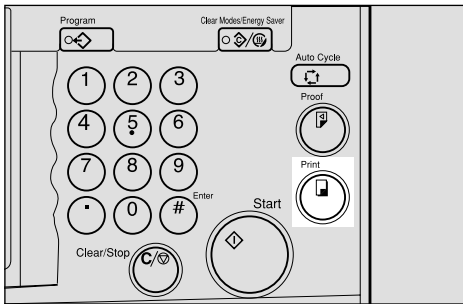

ZBHS320N

- 6** Remove the prints from the paper delivery tray and place them on the paper feed tray again as shown in the illustration.

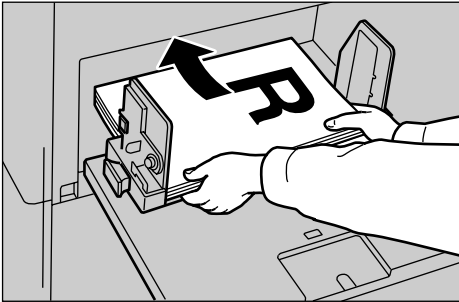

TPEY041E

- 7** Change the drum unit. See p.130 "Changing the Color Drum Unit".

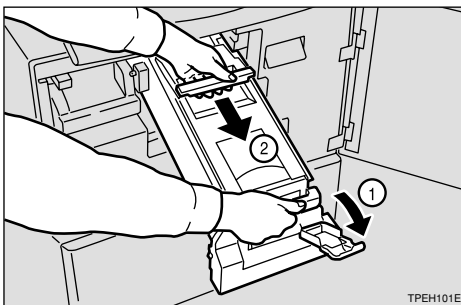

TPEH101E

- 8** Place the second original and press the **[Start]** key.
- 9** Check the image position.
- 10** Press the **[Print]** key.

## Changing the Drum Size

To save costs on master rolls and ink, you can shorten the length of each master by changing to an optional smaller drum.

2

### Printing Area (At 23°C/73°F, 65% RH)

#### ❖ Metric version

A3 drum	More than 290 × 410mm, 11.4" × 16.2"
A4 drum	More than 290 × 200mm

#### ❖ Inch version

11" × 17" drum	More than 290 × 420mm, 11.4" × 16.6"
8 <sup>1</sup> / <sub>2</sub> " × 11" drum	More than 11.4" × 7.8"

### Master Cut Length

A3 drum...320mm × 530mm, 12.5" × 20.9", 255 masters/roll

11" × 17" drum...320 × 540mm, 12.5" × 21.3", 245 masters/roll

Optional A4, 8<sup>1</sup>/<sub>2</sub>" × 11" drum...320mm × 325mm, 12.5" × 12.8", 410 masters/roll

#### Note

- ☐ For changing the drum unit, see p.130 "Changing the Color Drum Unit".

# 3. Combination Chart

## Combination Chart

This combination chart shows which modes can be used together.

☆	means that these modes can be used together.
X	means that these modes cannot be used together.
*1	means that these modes cannot be used together (the function chosen second takes priority).
*2	means that these modes cannot be used together (the function chosen first takes priority).

		Function chosen second																														
		Letter, Photo, Letter/Photo, Pencil, Tint mode	Economy mode	Auto Cycle	Preset Reduce/Enlarge	Zoom	Auto Magnification Selection	Directional Magnification (%)	Directional Magnification (size)	Combine Originals (2 Images on one sheet)	Combine Originals (4 Images on one sheet)	Memory Combine mode (4 Originals)	Memory Combine mode (8 Originals)	Memory Combine mode (16 Originals)	Edge Erase	All Class mode	Auto Class mode	Manual Class mode	Class mode	Job Separation	Overlay	Form	Storage Overlay	Date Stamp	Page Stamp	Stamp	Repeat	Make-up	Original Storage	Skip Feed	On Line	
Function specified earlier	Letter, Photo, Letter/Photo, Pencil, Tint mode	-	☆	☆	☆	☆	☆	☆	☆	☆	☆	☆	☆	☆	☆	☆	☆	☆	☆	☆	☆	☆	☆	☆	☆	☆	☆	☆	☆	☆	☆	☆
	Economy mode	☆	--	☆	☆	☆	☆	☆	☆	☆	☆	☆	☆	☆	☆	☆	☆	☆	☆	☆	☆	☆	☆	☆	☆	☆	☆	☆	☆	☆	☆	☆
	Auto Cycle	☆	☆	--	☆	☆	☆	☆	☆	☆	☆	☆	☆	☆	☆	☆	☆	☆	☆	☆	☆	☆	☆	☆	☆	☆	☆	☆	☆	☆	☆	☆
	Preset Reduce/Enlarge	☆	☆	☆	--	*	*	*	*	☆	☆	☆	☆	☆	☆	☆	☆	☆	☆	☆	☆	☆	☆	☆	☆	☆	☆	☆	*	*	☆	*
	Zoom	☆	☆	☆	*	--	*	*	*	☆	☆	☆	☆	☆	☆	☆	☆	☆	☆	☆	☆	☆	☆	☆	☆	☆	☆	☆	*	*	☆	*
Auto Magnification Selection	☆	☆	☆	*	*	--	*	*	☆	☆	☆	☆	☆	☆	☆	☆	☆	☆	☆	☆	☆	☆	☆	☆	☆	*	*	*	*	☆	*	

		Function chosen second																															
		Letter, Photo, Letter/Photo, Pencil, Tint mode	Economy mode	Auto Cycle	Preset Reduce/Enlarge	Zoom	Auto Magnification Selection	Directional Magnification (%)	Directional Magnification (size)	Combine Originals (2 Images on one sheet)	Combine Originals (4 Images on one sheet)	Memory Combine mode (4 Originals)	Memory Combine mode (8 Originals)	Memory Combine mode (16 Originals)	Edge Erase	All Class mode	Auto Class mode	Manual Class mode	Class mode	Job Separation	Overlay	Form	Storage Overlay	Date Stamp	Page Stamp	Stamp	Repeat	Make-up	Original Storage	Skip Feed	On Line		
Function specified earlier	Directional Magnification (%)	☆	☆	☆	1	1	1	-	☆	☆	☆	☆	☆	☆	☆	☆	☆	☆	☆	☆	☆	☆	☆	☆	☆	☆	☆	☆	☆	☆	☆	☆	
	Directional Magnification (size)	☆	☆	☆	1	1	1	-	☆	☆	☆	☆	☆	☆	☆	☆	☆	☆	☆	☆	☆	☆	☆	☆	☆	☆	☆	☆	☆	☆	☆	☆	
	Combine Originals (2 Images on one sheet)	☆	☆	☆	☆	☆	☆	☆	☆	-	1	1	1	1	☆	☆	☆	☆	☆	☆	☆	☆	☆	☆	☆	☆	☆	☆	☆	☆	☆	☆	
	Combine Originals (4 Images on one sheet)	☆	☆	☆	☆	☆	☆	☆	☆	1	-	1	1	1	☆	☆	☆	☆	☆	☆	☆	☆	☆	☆	☆	☆	☆	☆	☆	☆	☆	☆	
	Memory Combine mode (4 Originals)	☆	☆	☆	☆	☆	☆	☆	☆	1	1	-	1	1	☆	☆	☆	☆	☆	☆	☆	☆	☆	☆	☆	☆	☆	☆	☆	☆	☆	☆	
	Memory Combine mode (8 Originals)	☆	☆	☆	☆	☆	☆	☆	☆	1	1	1	-	1	☆	☆	☆	☆	☆	☆	☆	☆	☆	☆	☆	☆	☆	☆	☆	☆	☆	☆	
	Memory Combine mode (16 Originals)	☆	☆	☆	☆	☆	☆	☆	☆	1	1	1	1	-	☆	☆	☆	☆	☆	☆	☆	☆	☆	☆	☆	☆	☆	☆	☆	☆	☆	☆	
	Edge Erase	☆	☆	☆	☆	☆	☆	☆	☆	☆	☆	☆	☆	☆	☆	-	☆	☆	☆	☆	☆	☆	☆	☆	☆	☆	☆	☆	☆	☆	☆	☆	
	All Class mode	☆	☆	☆	☆	☆	☆	☆	☆	☆	☆	☆	☆	☆	☆	☆	-	1	1	1	1	☆	☆	☆	☆	☆	☆	☆	☆	☆	☆	☆	☆
	Manual Class mode	☆	☆	☆	☆	☆	☆	☆	☆	☆	☆	☆	☆	☆	☆	☆	☆	1	1	1	1	☆	☆	☆	☆	☆	☆	☆	☆	☆	☆	☆	☆

		Function chosen second																																
		Letter, Photo, Letter/Photo, Pencil, Tint mode	Economy mode	Auto Cycle	Preset Reduce/Enlarge	Zoom	Auto Magnification Selection	Directional Magnification (%)	Directional Magnification (size)	Combine Originals (2 Images on one sheet)	Combine Originals (4 Images on one sheet)	Memory Combine mode (4 Originals)	Memory Combine mode (8 Originals)	Memory Combine mode (16 Originals)	Edge Erase	All Class mode	Auto Class mode	Manual Class mode	Class mode	Job Separation	Overlay	Form	Storage Overlay	Date Stamp	Page Stamp	Stamp	Repeat	Make-up	Original Storage	Skip Feed	On Line			
Function specified earlier	Class mode	☆	☆	☆	☆	☆	☆	☆	☆	☆	☆	☆	☆	☆	☆	☆	☆	☆	☆	☆	☆	☆	☆	☆	☆	☆	☆	☆	☆	☆	☆	☆		
	Job Separation	☆	☆	☆	☆	☆	☆	☆	☆	☆	☆	☆	☆	☆	☆	☆	☆	☆	☆	☆	☆	☆	☆	☆	☆	☆	☆	☆	☆	☆	☆	☆		
	Overlay	☆	☆	☆	☆	☆	☆	☆	☆	*	*	*	*	*	☆	☆	☆	☆	☆	☆	☆	☆	*	*	*	*	*	*	*	*	*	*	*	
	Form	☆	☆	☆	☆	☆	☆	☆	☆	*	*	*	*	*	☆	☆	☆	☆	☆	☆	☆	☆	--	--	*	*	*	*	*	*	*	*	*	
	Storage Overlay	☆	☆	☆	☆	☆	☆	☆	☆	*	*	*	*	*	☆	☆	☆	☆	☆	☆	☆	☆	☆	☆	☆	☆	☆	☆	☆	☆	☆	☆	☆	
	Date Stamp	☆	☆	☆	☆	☆	☆	☆	☆	*	*	*	*	*	☆	☆	☆	☆	☆	☆	☆	☆	*	*	*	*	*	*	*	*	*	*	*	
	Page Stamp	☆	☆	☆	☆	☆	☆	☆	☆	*	*	*	*	*	☆	☆	☆	☆	☆	☆	☆	☆	*	*	*	*	*	*	*	*	*	*	*	
	Stamp	☆	☆	☆	☆	☆	☆	☆	☆	*	*	*	*	*	☆	☆	☆	☆	☆	☆	☆	☆	*	*	*	*	*	*	*	*	*	*	*	
	Repeat	☆	☆	☆	☆	☆	*	☆	☆	*	*	*	*	*	☆	☆	☆	☆	☆	☆	☆	☆	*	*	*	*	*	*	*	*	*	*	*	
	Make-up	*	☆	☆	☆	☆	☆	☆	☆	☆	☆	*	*	*	☆	☆	☆	☆	☆	☆	☆	☆	*	*	*	*	*	*	*	*	*	*	*	
	Original Storage	*	☆	☆	*	*	*	*	*	*	*	*	*	*	☆	☆	☆	☆	☆	☆	☆	☆	*	*	*	*	*	*	*	*	*	*	*	
	Skip Feed	☆	☆	☆	☆	☆	☆	☆	☆	☆	☆	☆	☆	☆	☆	☆	☆	☆	☆	☆	☆	☆	☆	☆	☆	☆	☆	☆	☆	☆	☆	☆	☆	
	On Line	*	☆	*	*	*	*	*	*	*	*	*	*	*	*	*	*	*	*	*	*	*	*	*	*	*	*	*	*	*	*	*	*	*
	Image Rotation	☆	☆	☆	☆	X	☆	X	X	X	X	☆	☆	☆	☆	☆	☆	☆	☆	☆	☆	☆	X	X	X	X	X	X	X	X	X	☆	X	



# 4. User Tools

## Accessing the User Tools

The user tools allow you to customize various default settings. This section is intended for the machine administrator.

- 1 Press the **[User Tools]** key.

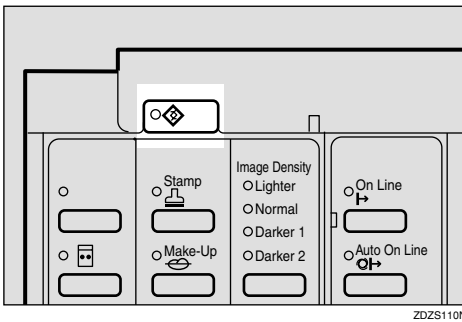

- 2 Select the desired user tools menu. See p.141 “User Tools Menu”.

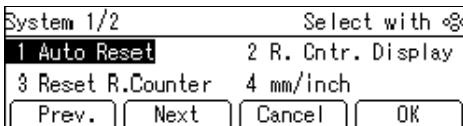

Using the **[◀]**, **[▶]**, **[▲]**, or **[▼]** key

- 1 Search for the desired user tool number (1 to 7) with the **[◀]**, **[▶]**, **[▲]**, or **[▼]** key.

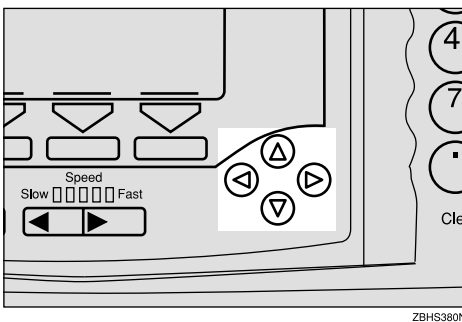

### Note

- **[Next]**: Press to go to the next page.
- **[Prev.]**: Press to go back to the previous page.

- 2 Press the **[OK]** key.
- 3 Search for the desired user tool number of each function with the **[◀]**, **[▶]**, **[▲]**, or **[▼]** key.
- 4 Press the **[OK]** key.

Using the number keys

- 1 Enter the desired user tool number (1 to 7) with the number keys.

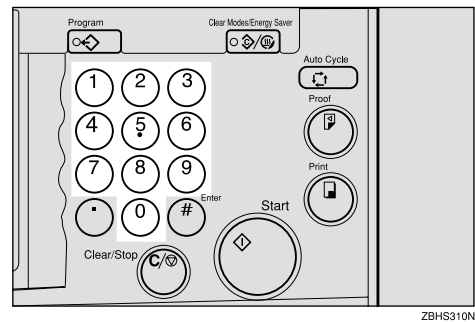

- 2 Press the **[OK]** or **[#]** key.
- 3 Enter the desired user tool number of each function with the number keys.
- 4 Press the **[OK]** or **[#]** key.

- 3** Change the settings by following the instructions on the panel display, and then press the **[OK]** key.

 **Note**

- To change the value entered, press the **[Clear/Stop]** key before pressing the **[OK]** key. Then enter the new value.
- [Cancel]**: Press to return to the previous menu without changing any data.

4

- 4** Press the **[User Tools]** key to return to the standby display.

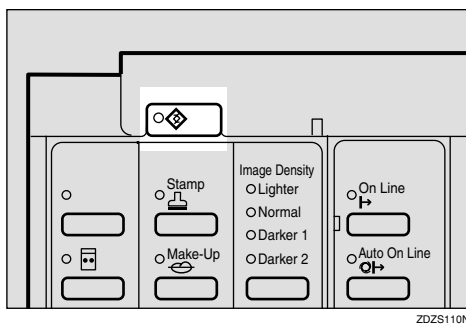

 **Note**

- The settings are not canceled even if the main switch is turned off or the **[Clear Modes/Energy Saver]** key is pressed.
- You can also return to the standby display by pressing the **[Cancel]** key.











# User Tools Menu

## Reference





For accessing the user tools, see p.139 “Accessing the User Tools”.

## 1. System









No.	Mode	Description
1	Auto Reset	<p>The machine returns to its initial condition automatically after your job is finished. The automatic reset time can be set from 1 to 5 minutes or off (0 minutes).</p> <p> <b>Note</b></p> <p><input type="checkbox"/> Default: <i>Off</i></p>
2	R. Cntr. Display	<p>Use to display the total number of masters and prints.</p> <p> <b>Note</b></p> <p><input type="checkbox"/> A trial print delivered to the paper delivery tray after pressing the <b>[Start]</b> key will not be counted.</p>
3	Reset R. Counter	<p>Choose whether the total number of masters and prints is reset.</p> <p> <b>Note</b></p> <p><input type="checkbox"/> Default: <i>Not clear</i></p>
4	mm/inch	<p>Choose the units of measurement shown on the panel display.</p> <p> <b>Note</b></p> <p><input type="checkbox"/> Default:</p> <ul style="list-style-type: none"> <li>• Metric version: <i>mm</i></li> <li>• Inch version: <i>inch</i></li> </ul>
5	Language on LCD	<p>The language used for panel display messages can be selected.</p> <p> <b>Note</b></p> <p><input type="checkbox"/> Default: <i>English</i></p>
6	Time Setting	<p>Use to set the machine's internal clock.</p> <p> <b>Note</b></p> <p><input type="checkbox"/> The clock must be adjusted if you change the clock to daylight saving time/summer time, or return to standard time.</p> <p> <b>Reference</b></p> <p>For setting the clock, see p.153 “1-6 Time Setting”.</p>





No.	Mode	Description
7	Data Print	Use to print out the following data.  <b>Note</b> <input type="checkbox"/> Available settings: <ul style="list-style-type: none"> <li>• Log Data (Number of prints made, how many times paper misfeeds occur and so on.)</li> <li>• Reset Counters (Number of prints and master made under each user code.)</li> <li>• Store Class (Registered number of students in each class.)</li> </ul>
8	Energy Saving	You can set the time until the Energy Saver mode starts.  <b>Note</b> <input type="checkbox"/> Default: <i>3 Min.</i> (minutes)

## 2. Set Operat'n Mode





No.	Mode	Description
1	Min. Quantity	The minimum print quantity can be set between 0 and 9999. Example: If you specify 20 as the minimum number of prints, runs of 20 or more prints will be accepted, print runs of less than 20 prints will not be accepted.  <b>Note</b> <input type="checkbox"/> Default: <i>0</i>
2	Max. Quantity	The maximum print quantity can be set between 0 and 9999.  <b>Note</b> <input type="checkbox"/> Default: <i>9999</i>
3	CopyCount Display	The counter can be set to show the number of prints made (Up), or the number of prints left to be made (Down).  <b>Note</b> <input type="checkbox"/> Default: <i>Down</i>
5	Panel Beeper	Turns the beeper on or off.  <b>Note</b> <input type="checkbox"/> Default: <i>STD.</i> (standard) <input type="checkbox"/> Available settings: <ul style="list-style-type: none"> <li>• ALL OFF (The beeper does not sound when you press keys or when warning messages appear on the panel display.)</li> <li>• STD. (When you press a key, the beeper does not sound. When warning messages appear on the panel display, the beeper sounds.)</li> <li>• ALL ON (The beeper sounds when you press a key or when warning messages appear on the panel display.)</li> </ul>
6	LCD Contrast	You can adjust the brightness of the panel display.







### 3. Initial Setting







No.	Mode	Description
1	Paper Type	<p>Specifies the paper type at power on.</p> <p> <b>Note</b></p> <p><input type="checkbox"/> Default: <i>Std.</i> (Standard)</p>
2	MSTR Makg. Density	<p>Specifies the image density at power on.</p> <p> <b>Note</b></p> <p><input type="checkbox"/> Default: <i>Std.</i> (Standard)</p>
3	Original Priority	<p>Specifies the original mode at power on.</p> <p> <b>Note</b></p> <p><input type="checkbox"/> Default: <i>Letter</i></p>
4	Reproduct'n Ratio	<p>Adjust a fixed reproduction ratio between 50 and 200%.</p> <p> <b>Note</b></p> <p><input type="checkbox"/> Default:</p> <ul style="list-style-type: none"> <li>• Metric version: 71%, 82%, 87%, 93%, 100%, 115%, 122%, 141%</li> <li>• Inch version: 65%, 74%, 77%, 93%, 100%, 121%, 129%, 155%</li> </ul> <p> <b>Reference</b></p> <p>For setting the ratios, see p.154 "3-4 Reproduction Ratio".</p>
5	Class Enter No.	<p>Before using All Class or Auto Class mode, register the number of students in each class with this function.</p> <p> <b>Note</b></p> <p><input type="checkbox"/> You can store student numbers for up to 9 grades with 12 classes in each, giving a maximum of 108 classes. Each class can have up to 9999 students.</p> <p> <b>Reference</b></p> <p>For registering the number of students, see p.154 "3-5 Class Enter No.".</p>
6	LT/Photo Contrast	<p>Specifies the contrast level for Letter/Photo when the power is switched on or after mode settings are cleared.</p> <p> <b>Note</b></p> <p><input type="checkbox"/> Default: <i>Standard</i></p>
7	LT/Photo Priority	<p>Specifies the screen image in Letter/Photo mode when you press the <b>[Original]</b> key.</p> <p> <b>Note</b></p> <p><input type="checkbox"/> Default: <i>Letter</i></p>





No.	Mode	Description
8	Photo Contrast	Specifies the contrast level for Photo when the power is switched on or after mode settings are cleared.  <b>Note</b> <input type="checkbox"/> Default: <i>Standard</i>
9	Photo(Screen)	Specifies the screen image in Photo mode when you press the <b>[Original]</b> key.  <b>Note</b> <input type="checkbox"/> Default: <i>Standard</i>
10	Eco.Mode ON/OFF	Specifies whether Economy Mode is set to “On” or “Off” when the power is switched on or after mode settings are cleared.  <b>Note</b> <input type="checkbox"/> Default: <i>Off</i>
11	Margin Eras.Area	Adjusts the erase edges margin.  <b>Note</b> <input type="checkbox"/> Default: <i>2 mm, 0.1”</i>
12	Ratio Priority	You can set the primary ratio on the display when you press the <b>[Ratio]</b> key.



## 4. Mode Setting

No.	Mode	Description
1	Auto Cycle ON/OFF	Specifies whether Auto Cycle mode is selected at power on.  <b>Note</b> <input type="checkbox"/> Default: <i>ON</i>
2	Class Manual Set	Use one original or multiple originals in Manual Class mode.  <b>Note</b> <input type="checkbox"/> Default: <i>Std. (One original)</i>
3	Ignore Paper Size	If you are making prints on non-standard paper and the original image does not entirely appear on the print, set paper size detection to “Ignore”. The machine will not detect the paper length.  <b>Note</b> <input type="checkbox"/> Default: <i>Not to ignore</i>
4	No Orig. Size DF	When you set long originals in the optional document feeder, set original detection to “Ignore”. The machine will not detect the original size.  <b>Note</b> <input type="checkbox"/> Default: <i>Not to ignore</i>





No.	Mode	Description
5	No Orig. Size	<p>When you place originals of non standard sizes on the exposure glass, set original detection to "Ignore". The machine will not detect the original size.</p> <p> <b>Note</b></p> <p><input type="checkbox"/> Default: <i>Not to ignore</i></p>
6	Background ON/OFF	<p>When you make prints in Photo, Letter/Photo, or Tint mode, the background of the prints might become dirty. Turn Background "On" to improve the clarity of your prints.</p> <p> <b>Note</b></p> <p><input type="checkbox"/> Default: <i>W/O back. correction (off)</i></p>
7	Longer Paper	<p>Use paper longer than 432mm, 17.0".</p> <p> <b>Note</b></p> <p><input type="checkbox"/> Default: <i>Not to use</i></p>
8	Combine	<p>If you select "Automatic (Auto Combine mode)", you can make two or four identical images on one sheet by pressing the <b>[Combine]</b> key and <b>[Start]</b> key.</p> <p> <b>Note</b></p> <p><input type="checkbox"/> Default: <i>Normal (Combine Originals mode)</i></p> <p> <b>Reference</b></p> <p>For using Auto Combine mode, see p.68 "Auto Combine Mode".</p>
9	Comb. Sep. Line	<p>You can select a separation line in Memory Combine mode.</p> <p> <b>Note</b></p> <p><input type="checkbox"/> Default: <i>None</i></p> <p><input type="checkbox"/> Available settings:</p> <div data-bbox="522 1248 985 1441" style="border: 1px solid black; padding: 5px; margin: 10px 0;"> <p style="text-align: right; font-size: small;">GRLINEOE</p> </div> <ul style="list-style-type: none"> <li>• a = None</li> <li>• b = Solid</li> <li>• c = Broken1</li> <li>• d = Broken2</li> <li>• e = CropMarks</li> </ul>

No.	Mode	Description
10	Cancel Comb.	<p>Specifies whether Combine Originals or Memory Combine mode is cleared after finishing your print job.</p> <p> <b>Note</b></p> <p><input type="checkbox"/> Default: <i>Not to cancel</i></p>
11	No. of Skip Feed	<p>Specifies the number of drum rotations in Skip Feed mode at power on. You can also select whether you can change the number of drum rotations temporarily when you press the <b>【Skip Feed】</b> key. See p.70 “Skip Feed Printing”.</p> <p> <b>Note</b></p> <p><input type="checkbox"/> Default:</p> <ul style="list-style-type: none"> <li>• Panel display: <i>Display</i></li> <li>• Number of Skip Feed: 2</li> </ul> <p> <b>Reference</b></p> <p>For changing the number of rotations, see p.156 “4-11 No. of Skip Feed”.</p>
12	Idling for Q.start	<p>When you use the Manual Quality Start mode, you can select how many times the drum unit idles.</p> <p> <b>Note</b></p> <p><input type="checkbox"/> Default: 7</p>
13	Setting Q.start	<p>If the machine is not used for a long period of time, the ink on the drum might dry causing image quality to deteriorate. The Auto Quality Start mode automatically recovers image density quality after a selected time has passed. If Auto Quality Start mode is set to “Not to use”, you can regain print quality by making a few extra prints or you can use the Manual Quality Start mode.</p> <p> <b>Note</b></p> <p><input type="checkbox"/> Default: Yes</p>
14	No. of Q.start	<p>You can select how many times the drum unit idles after the displayed time periods have passed in Auto Quality Start mode.</p> <p> <b>Note</b></p> <p><input type="checkbox"/> Default: See p.157 “4-14 No. of Q.start”.</p> <p><input type="checkbox"/> To increase the print image density, increase the number of drum rotations, and vice versa.</p> <p> <b>Reference</b></p> <p>For changing the number of idle spins, see p.157 “4-14 No. of Q.start”.</p>











No.	Mode	Description
15	Deflector Angle	<p>You can change the angle of the wing guide depending on the paper type you use.</p> <p> <b>Note</b></p> <ul style="list-style-type: none"> <li><input type="checkbox"/> Default: <i>Auto</i></li> <li><input type="checkbox"/> Available settings: <ul style="list-style-type: none"> <li>• Up (Select this setting when standard thickness or thin paper misfeeds at the paper exit section occur frequently.)</li> <li>• Down (Select this setting when A4 – B5, 8<sup>1</sup>/<sub>2</sub>" × 11" thick paper is not delivered properly to the paper delivery tray.)</li> </ul> </li> </ul>
16	Auto Class	<p>When you do not use the Separation mode, you can select the machine's condition after each printing set is fed out to the paper delivery tray.</p> <p> <b>Note</b></p> <ul style="list-style-type: none"> <li><input type="checkbox"/> Default: <i>Stop</i></li> <li><input type="checkbox"/> Available settings: <ul style="list-style-type: none"> <li>• Start printing automatically (After the last page of each printing set is fed out to the paper delivery tray, the machine stops for a few seconds. Then, the next cycle begins.)</li> <li>• Stop (After the last page of each printing set is fed out to the paper delivery tray, the machine stops. If you press the <b>[Print]</b> key, the next cycle begins.)</li> </ul> </li> </ul>
17	Auto Separate	<p>Specifies whether Job Separation mode is automatically carried out when you make prints in All Class, Auto Class, Manual Class, or Class mode.</p> <p> <b>Note</b></p> <ul style="list-style-type: none"> <li><input type="checkbox"/> Default: <i>ON</i></li> </ul>
18	Ink/Master Left	<p>Specifies whether you can check the amount of ink and master.</p> <p> <b>Note</b></p> <ul style="list-style-type: none"> <li><input type="checkbox"/> Default: <i>OFF</i></li> <li><input type="checkbox"/> Available settings: <ul style="list-style-type: none"> <li>• OFF (You cannot check the remaining amount of ink or master.)</li> <li>• ON (When the remaining amount of ink or master is less than half, the panel display indicates these amounts when you turn on the main switch.)</li> <li>• Check remaining volume (You can see the remaining amounts of ink and master regardless of these amounts.)</li> </ul> </li> </ul>
19	Type of Paper	<p>When one kind of paper misfeed occur frequently, you can register its paper type in "User1" or "User2".</p> <p> <b>Reference</b></p> <p>For registering a special paper type, see p.158 "4-19 Type of Paper".</p>

No.	Mode	Description
20	Auto Rotation	When the direction in which your original is placed differs from that of the paper, the machine automatically rotates the original image by 90° to match the paper direction. You can cancel this setting.  <b>Note</b> <input type="checkbox"/> Default: <i>ON</i>
21	Master length	The machine determines the master length according to the number of originals placed in the optional document feeder and the paper sizes. If you wish to use A3/11" × 17" master regardless of the number of originals set and the paper sizes, select "A3".  <b>Note</b> <input type="checkbox"/> Default: <i>Auto</i>
27	Cancel Stor.O.lay	Specifies whether settings for Storage Overlay are retained, or not, when a storage overlay job has finished.  <b>Note</b> <input type="checkbox"/> Default: <i>Not to cancel</i>

## 5. Stamp

No.	Mode	Description
1	Type	You can select the stamp message at power on with the Stamp mode.  <b>Note</b> <input type="checkbox"/> Default: <i>CONFIDENTIAL</i>
2	Size	You can edit the preset stamp sizes.  <b>Note</b> <input type="checkbox"/> Default: <i>Standard</i> <input type="checkbox"/> Adjustment values: <ul style="list-style-type: none"> <li>• Double size</li> </ul>
3	Stamp Density	You can select the style of the stamps.  <b>Note</b> <input type="checkbox"/> Default: <i>Solid-fill</i>
4	Stamp Position	You can edit the preset stamp position.  <b>Note</b> <input type="checkbox"/> Default: See p.159 "5-4 Stamp Position". <input type="checkbox"/> Available settings: See p.159 "5-4 Stamp Position".  <b>Reference</b> For adjusting the stamp position, see p.159 "5-4 Stamp Position".













No.	Mode	Description
5	Date Style Set	You can select the format of the date stamp.  <b>Note</b> <input type="checkbox"/> Default: <i>Month Day Year</i>
6	Date Position Set	You can select the date stamp direction at power on in Date Stamp mode.  <b>Note</b> <input type="checkbox"/> Default: <i>Upper Left</i>
7	Position(Date)	You can edit the date stamp position.  <b>Note</b> <input type="checkbox"/> Default: See p.160 "5-7 Position (Date)". <input type="checkbox"/> Available settings: See p.160 "5-7 Position (Date)".  <b>Reference</b> For adjusting the date stamp position, see p.160 "5-7 Position (Date)".
8	Type(Page)	You can select the page numbering style at power on in Page Stamp mode.  <b>Note</b> <input type="checkbox"/> Default: <i>P1,P2</i>
9	Direction(Page)	You can select the page numbering direction at power on in Page Stamp mode.  <b>Note</b> <input type="checkbox"/> Default: <ul style="list-style-type: none"> <li>• When you select "P1,P2" or "1/5,2/5" with the "Type(Page)" user tool: <i>Upper Right</i></li> <li>• When you select "-1,-,2-" with the "Type(Page)" user tool: <i>Down Center</i></li> </ul>
10	Position(Page)	You can edit the page numbering position.  <b>Note</b> <input type="checkbox"/> Default: See p.161 "5-10 Position (Page)". <input type="checkbox"/> Available settings: See p.161 "5-10 Position (Page)".  <b>Reference</b> For adjusting the page numbering position, see p.161 "5-10 Position (Page)".
11	Make/Chg. Pattern	Make your own background pattern in Make-up mode.  <b>Note</b> <input type="checkbox"/> You can edit the 40 preset patterns.  <b>Reference</b> For changing the background pattern, see p.163 "5-11 Make/Chg. Pattern".

## 6. Administrator Mode





### ❖ User Codes









If user codes are turned on, operators must enter their user codes before they can operate the machine. The machine keeps count of the number of copies made under each user code. Turn this function on with the “Set User Code(s)” user tool. You can also turn on Key Operator Code mode so that only the key operator (administrator) can use the functions below.

1	Check Counter	<p>You can check the number of masters and copies made under each user code.</p> <p> <b>Reference</b> For checking the number of masters and copies, see p.164 “6-1 Check Counter”.</p>
2	Reset Counters	<p>You can clear each or all user code counters.</p> <p> <b>Note</b> <input type="checkbox"/> Default: <i>Single</i></p> <p> <b>Reference</b> For clearing the number of masters and copies, see p.164 “6-2 Reset Counters”.</p>
3	Set User Code	<p>Selects User Code mode. For details about User Code mode, see p.150 “6. Administrator Mode” Use Code(s). Enter the key Operator Code if you have already set it. See p.150 “6. Administrator Mode”.</p> <p> <b>Note</b> <input type="checkbox"/> Default: <i>Not to use</i></p>
4	Reg. User Code	<p>You can register user codes.</p> <p> <b>Note</b> <input type="checkbox"/> Up to 20 user codes (up to 4 digits) can be registered.</p>
5	Chg. User Code	<p>You can change user codes.</p> <p> <b>Note</b> <input type="checkbox"/> The number of copies made under the old code is added to that made under the new user code.</p> <p> <b>Reference</b> For changing the user codes, see p.165 “6-5 Chg. User Code”.</p>

6	Del. User Code	<p>You can delete user codes.</p> <p> <b>Note</b></p> <p><input type="checkbox"/> The number of copies made under the deleted code is also deleted.</p> <p> <b>Reference</b></p> <p>For deleting user codes, see p.166 “6-6 Del. User Code”.</p>
7	Key Operator Code	<p>Use to turn Key Operator Code mode on or off.</p> <p> <b>Note</b></p> <p><input type="checkbox"/> Default: <i>Not to use</i></p>
8	Reg/Chg Key-OpCode	<p>You can register or change key operator codes. (up to 4 digits)</p>
9	Restrict. Access	<p>In Key Counter mode, you have to set the key counter before making prints. (To turn on Key Counter mode, contact your service representative.) If Key Counter mode is on, Restricted Access is turned on (“To use”) automatically. If you turn Restricted Access off (“Not to use”), you can make prints without inserting the key counter.</p> <p> <b>Note</b></p> <p><input type="checkbox"/> Default: <i>Not to use</i></p>

## 7. On Line Mode

No.	Mode	Description
1	Set aut-O/L def	<p>Specifies whether Auto On Line mode is set to “On” or “Off” when power is switched on or after mode settings are cleared.</p> <p> <b>Note</b></p> <p><input type="checkbox"/> Default: <i>On</i></p>
2	Ppr. Size [Online]	<p>Specifies the paper size when you press the <b>[On Line]</b> key.</p> <p> <b>Note</b></p> <p><input type="checkbox"/> Default: <i>Auto</i></p>
3	List/Test Print	<p>Prints the current set content of this machine.</p> <p> <b>Note</b></p> <p><input type="checkbox"/> Default: <i>System Print</i></p>
4	Print PS Errors	<p>Setting for when printing the PS Error List when a PostScript error occurs.</p> <p> <b>Note</b></p> <p><input type="checkbox"/> Default: <i>Off</i></p>

No.	Mode	Description
5	IP Address	<p>Sets the IP Address.</p> <p> <b>Note</b>  <input type="checkbox"/> Default: <i>011.022.033.044</i></p> <p> <b>Reference</b>                      See the Printer Reference 1 for information about the IP Address setting.</p>
6	Ethernet Speed	<p>Sets the Ethernet communication speed.</p> <p> <b>Note</b>  <input type="checkbox"/> Default: <i>Auto</i></p>
7	Network	<p>Sets the Network boot.</p> <p> <b>Note</b>  <input type="checkbox"/> Default: <i>NONE</i></p> <p> <b>Reference</b>                      See the Printer Reference 1 for information about the Network boot setting.</p>
8	I/O Timeout	<p>Sets the time to enable the interface after data stops being received. When the time set here is exceeded, it will be possible to receive data from the other interface.</p> <p> <b>Important</b>  <input type="checkbox"/> If the set time is too short, a time out might occur while one data is being received. As a result, data from another interface might cut in and be printed, or the emulation retrieval from half of the data may be activated, and be replaced with a different emulation.</p> <p> <b>Note</b>  <input type="checkbox"/> Default: <i>30 sec.</i></p>
9	I/O Buffer	<p>Sets the capacity of the reception buffer.</p> <p> <b>Note</b>  <input type="checkbox"/> Default: <i>512KB</i></p>
10	Menu Reset	<p>You can reset the factory settings. However, the “IP Address”, “Network”, and the “Ethernet Speed” settings do not change.</p>

# User Tool Menus in Detail

## 1-6 Time Setting

**1** Press the **[User Tools]** key.

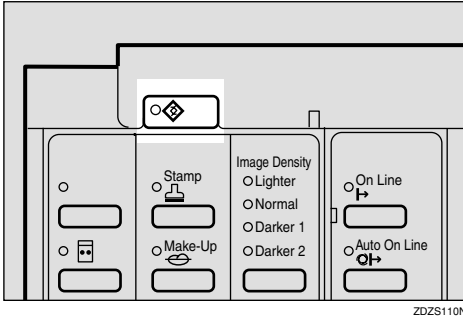

**2** Make sure that "1" is selected, and then press the **[OK]** key.

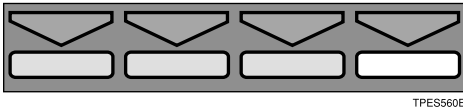
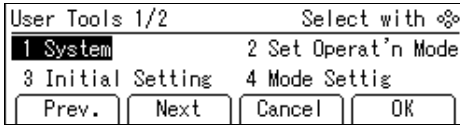

**3** Enter 6 with the number keys, and then press the **[OK]** or **[#]** key.

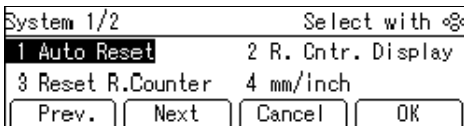

**4** Enter the year with the number keys.

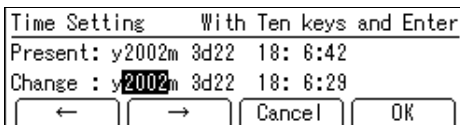

**5** Press the **[#]** key.

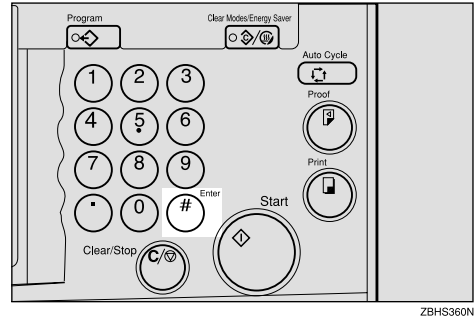

**6** Enter the month with the number keys.

**7** Press the **[#]** key.

### Note

- Follow steps **6** and **7** for the "date", "hour", "minute", and "second".

**8** Press the **[OK]** key.

### 3-4 Reproduction Ratio

**1** Press the **[User Tools]** key.

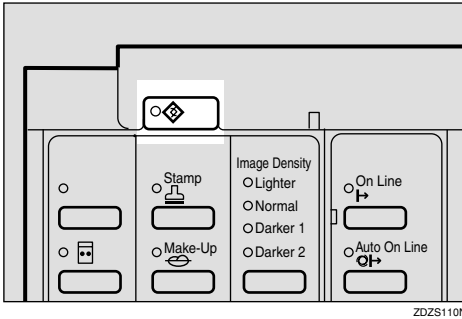

**2** Enter 3 with the number keys, and then press the **[OK]** or **[#]** key.

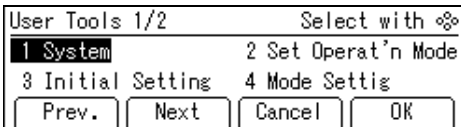

**3** Enter 4 with the number keys, and then press the **[OK]** or **[#]** key.

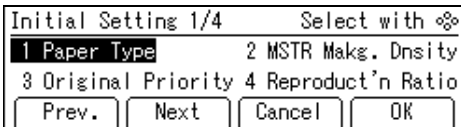

**4** Select the ratio you want to adjust with the **[←]** **[→]** or **[<]** **[>]** keys.

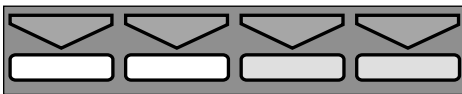
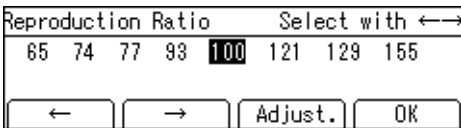

**5** Press the **[Adjust.]** key.

**6** Enter the desired ratio with the **[←]** **[→]** or **[<]** **[>]** keys.

**Note**

You can also enter the ratio with the number keys.

**7** Press the **[OK]** key twice.

### 3-5 Class Enter No.

**1** Press the **[User Tools]** key.

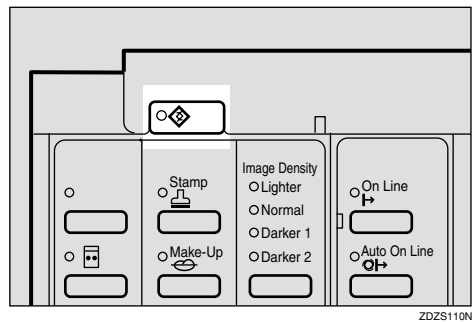

**2** Enter 3 with the number keys, and then press the **[OK]** or **[#]** key.

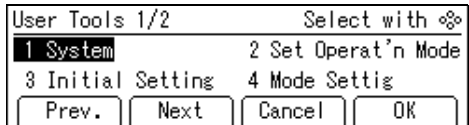

**3** Enter 5 with the number keys, and then press the **[OK]** or **[#]** key.

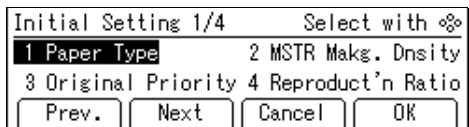

- 4** Select the grade with the [←] [→] or [◀] [▶] keys.

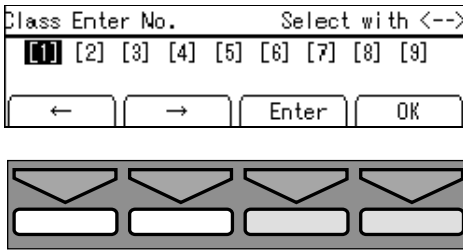

TPES530E

- 5** Press the [Enter] key.

- 6** Select the class with the [←] [→] or [◀] [▶] keys.

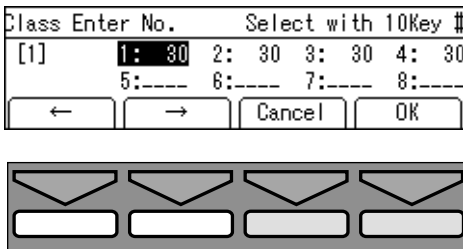

TPES530E

- 7** Enter the number of students with the number keys, and then press the [#] key.

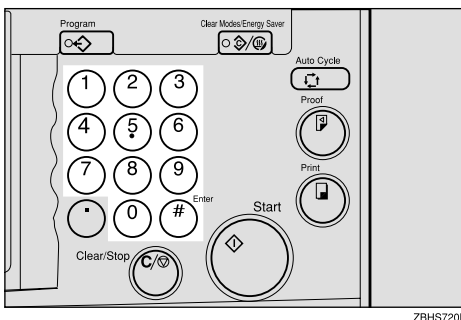

ZBHS720N

**Note**

- Repeat steps **6** and **7** until you have finished registering the number of students in each class.

- 8** Press the [OK] key.

**Note**

- Repeat steps **4** through **8** until you have finished registering the number of students in each class for the each grades.

- 9** Press the [OK] key.

### 3-11 Margin Erase Area

- 1** Press the [User Tools] key.

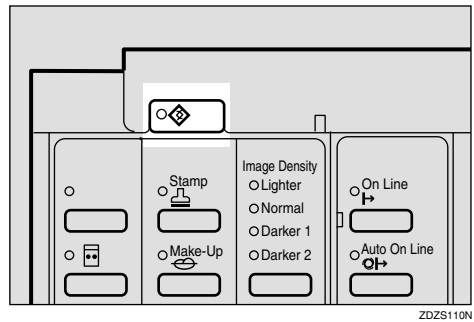

ZDZS110N

- 2** Enter 3 with the number keys, and then press the [OK] or [#] key.

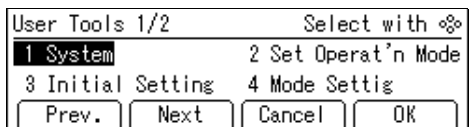

- 3** Enter 11 with the number keys, and then press the [OK] or [#] key.

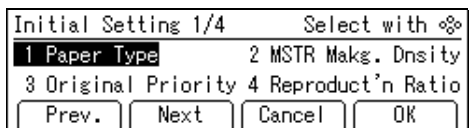

- 4 Select the original size you will use with the [←] [→] or [◀] [▶] keys.

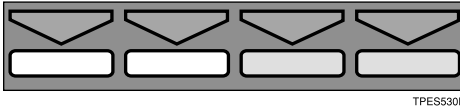
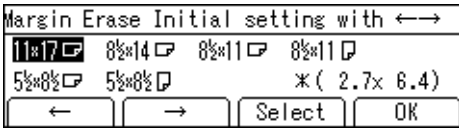

TPES530E

- 5 Press the [Select] key.

- 6 Adjust the erase edge margin.

If you selected A3 to A6 or 11" × 17" to 5<sup>1</sup>/<sub>2</sub>" × 8<sup>1</sup>/<sub>2</sub>"

- 1 Adjust the erase edge margin with the [←] [→] or [◀] [▶] keys.

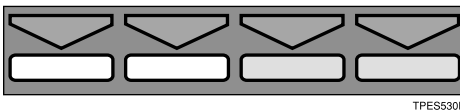
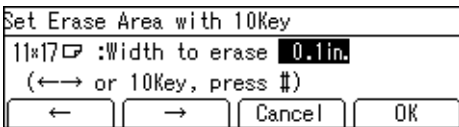

TPES530E

**Note**

- You can also enter the ratio with the number keys and the [#] key.

If you selected \*

- 1 Enter the erase edge margin with the number keys.

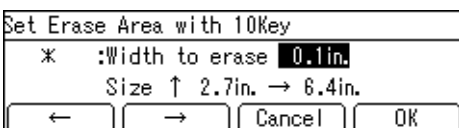

- 2 Press the [#] key.

- 3 Enter the vertical length with the number keys.

- 4 Press the [#] key.

- 5 Enter the horizontal width with the number keys.

- 6 Press the [#] key.

- 7 Press the [OK] key twice.

## 4-11 No. of Skip Feed

The following procedure explains how to change the number of drum rotations.

- 1 Press the [User Tools] key.

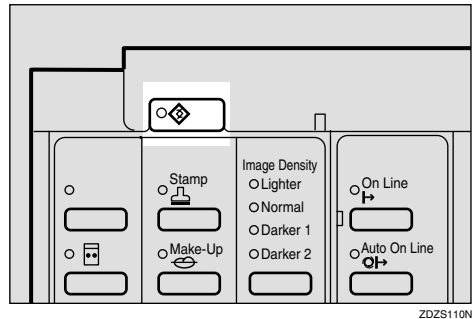

ZDZS110N

- 2 Enter 4 with the number keys, and then press the [OK] or [#] key.

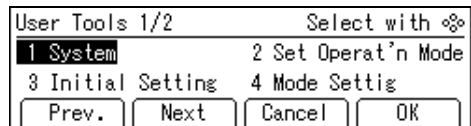

- 3 Enter 11 with the number keys, and then press the [OK] or [#] key.

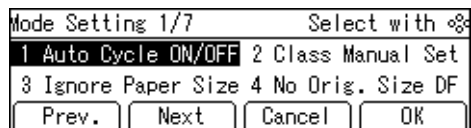

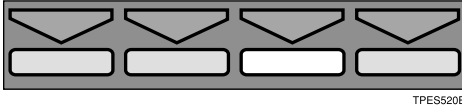
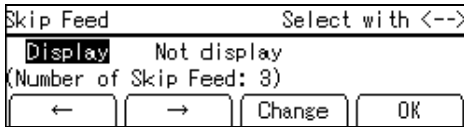

**4** Press the [Change] key.

TPES520E

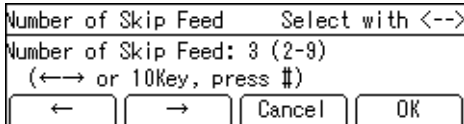
**5** Change the number of drum rotations while one sheet of paper is fed with the [←] [→] or [◀] [▶] keys.

TPES330E

**Note**

- You can also change the number of rotations with the number keys.

**6** Press the [OK] key.**4-14 No. of Q.start****Note**

- The default settings are as follows.

		Time period			
		0 - 4 hours	4 - 24 hours	24 - 72 hours	More than 72 hours
Temperature	Low Tmp. *1	0	15	45	45
	Normal Tmp. *2	0	0	15	15
	High Tmp. *3	0	0	0	15

\*1 (10 - 15°C, 50 - 59°F)

\*2 (15 - 28°C, 59 - 82.4°F)

\*3 (28 - 30°C, 82.4 - 86°F)

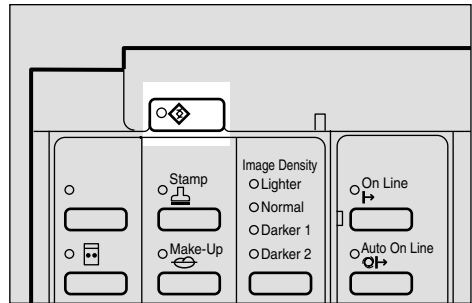
**1** Press the [User Tools] key.

ZDZS110N

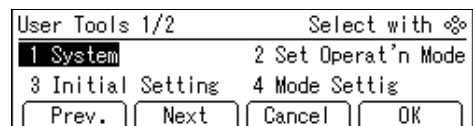
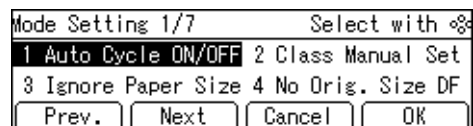
**2** Enter 4 with the number keys, and then press the [OK] or [#] key.**3** Enter 14 with the number keys, and then press the [OK] or [#] key.

- 4** Select the temperature at which you use this machine with the [←] [→] or [◀] [▶] keys.

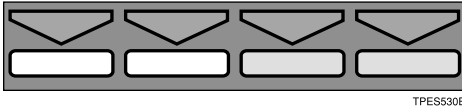
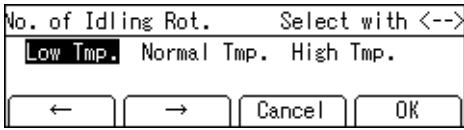

TPES530E

- 5** Press the [OK] key.

- 6** Select the time period (hours) the drum unit idles for with the [←] [→] or [◀] [▶] keys.

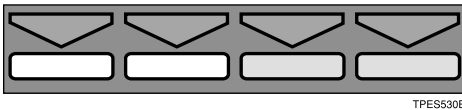
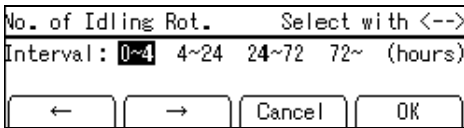

TPES530E

- 7** Press the [OK] key.

- 8** Select the number of drum rotations with the [←] [→] or [◀] [▶] keys.

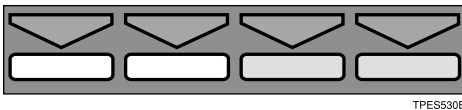
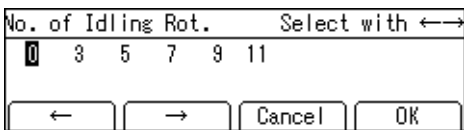

TPES530E

- 9** Press the [OK] key.

## 4-19 Type of Paper

- 1** Press the [User Tools] key.

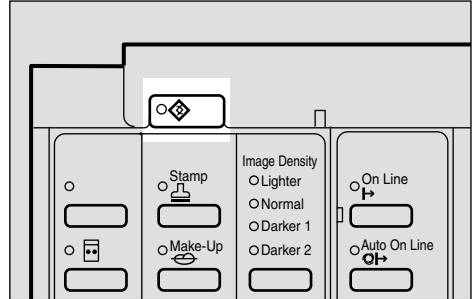

ZDZS110N

- 2** Enter 4 with the number keys, and then press the [OK] or [#] key.

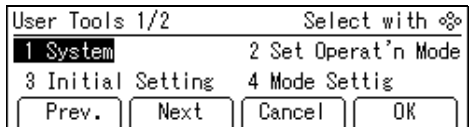

- 3** Enter 19 with the number keys, and then press the [OK] or [#] key.

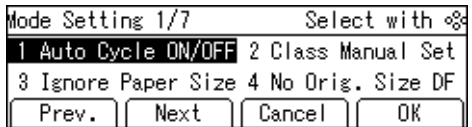

- 4** Select [User1] or [User2] with the [←] [→] or [◀] [▶] keys.

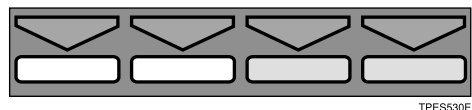
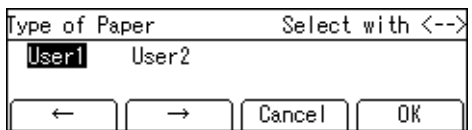

TPES530E

- 5** Press the [OK] key.

**6** Select the paper type and misfeed condition with the [←] or [→] key.

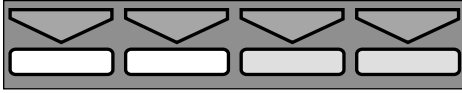
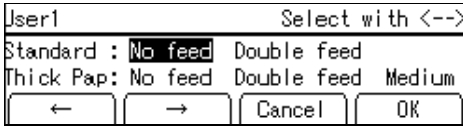

TPES530E

**7** Press the [OK] key.

**8** Press the [Cancel] key.

## 5-4 Stamp Position

### Note

- The default position and available settings of each stamp are as follows.

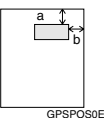
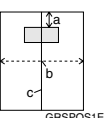
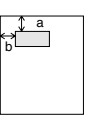
Stamp positions	Default	Available settings
	a = 24mm, 0.96" b = 24mm, 0.96"	a = 8 – 104mm, 0.32" – 4.16" b = 8 – 144mm, 0.32" – 5.76"
	a = 24mm, 0.96" b = 0mm, 0" c = center line	a = 8 – 104mm, 0.32" – 4.16" b = -72 – 72mm, -2.88" – 2.88"
	a = 24mm, 0.96" b = 24mm, 0.96"	a = 8 – 104mm, 0.32" – 4.16" b = 8 – 144mm, 0.32" – 5.76"

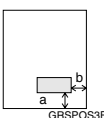
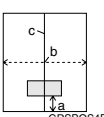
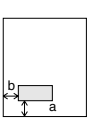
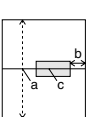
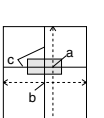
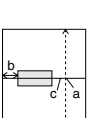
Stamp positions	Default	Available settings
	a = 24mm, 0.96" b = 24mm, 0.96"	a = 8 – 104mm, 0.32" – 4.16" b = 8 – 144mm, 0.32" – 5.76"
	a = 24mm, 0.96" b = 0mm, 0" c = center line	a = 8 – 104mm, 0.32" – 4.16" b = -72 – 72mm, -2.88" – 2.88"
	a = 24mm, 0.96" b = 24mm, 0.96"	a = 8 – 104mm, 0.32" – 4.16" b = 8 – 144mm, 0.32" – 5.76"
	a = 0mm, 0" b = 24mm, 0.96" c = center line	a = -52 – 52mm, -2.08" – 2.08" b = 8 – 144mm, 0.32" – 5.76"
	a = 0mm, 0" b = 0mm, 0" c = center line	a = -52 – 52mm, -2.08" – 2.08" b = -72 – 72mm, -2.88" – 2.88"
	a = 0mm, 0" b = 24mm, 0.96" c = center line	a = -52 – 52mm, -2.08" – 2.08" b = 8 – 144mm, 0.32" – 5.76"

**1** Press the **[User Tools]** key.

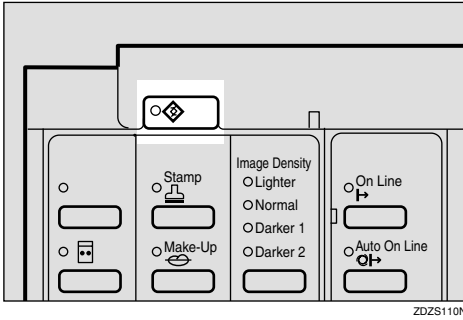

**2** Enter 5 with the number keys, and then press the **[OK]** or **[#]** key.

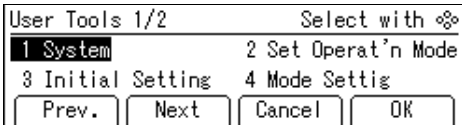

**3** Enter 4 with the number keys, and then press the **[OK]** or **[#]** key.

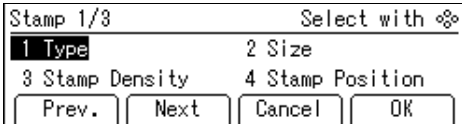

**4** Select the stamp position you want with the **[←]** **[→]** or **[◀]** **[▶]** keys.

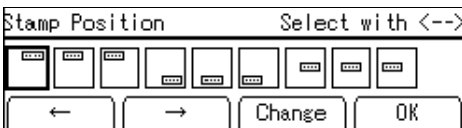

**5** Press the **[Change]** key.

**6** Adjust the horizontal stamp position with the **[Δ]** or **[▽]** key, and then press the **[▶]** key.

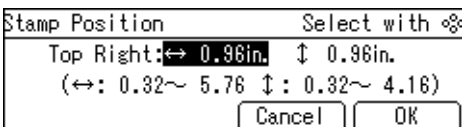

**Note**

- The value increases or decreases in 4mm, 0.16" steps.

**7** Adjust the vertical stamp position with the **[Δ]** or **[▽]** key.

**8** Press the **[OK]** key twice.

## 5-7 Position (Date)

**Note**

- The default position and available settings of each date stamp are as follows.

Stamp positions	Default	Available settings
	a = 8mm, 0.32" b = 20mm, 0.80"	a = 8 – 40mm, 0.32" – 1.60" b = 8 – 40mm, 0.32" – 1.60"
	a = 20mm, 0.80" b = 12mm, 0.48"	
	a = 20mm, 0.80" b = 8mm, 0.32"	

**1** Press the **[User Tools]** key.

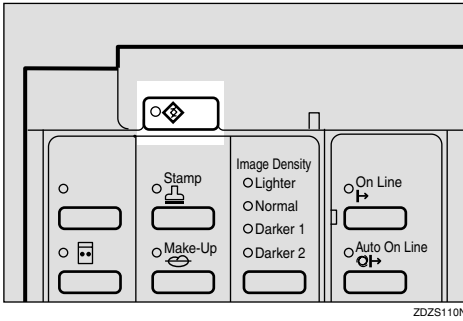

ZDZS110N

**2** Enter 5 with the number keys, and then press the **[OK]** or **[#]** key.

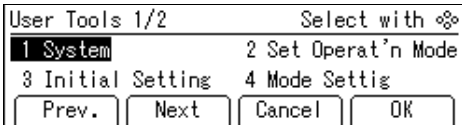

**3** Enter 7 with the number keys, and then press the **[OK]** or **[#]** key.

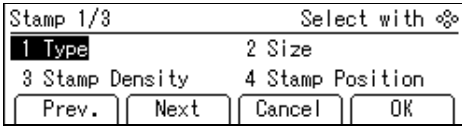

**4** Select the date stamp position you want to adjust with the **[←]**, **[→]** or **[<]**, **[>]** keys.

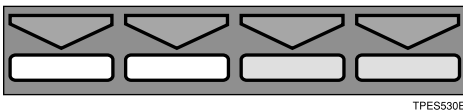
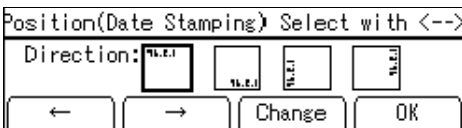

TPES330E

**5** Press the **[Change]** key.

**6** Adjust the horizontal date stamp position with the **[Δ]** or **[▽]** key, and then press the **[▷]** key.

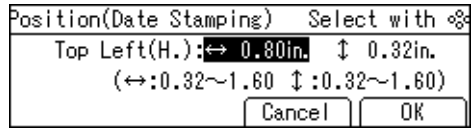

**Note**

- The value increases or decreases in 4mm, 0.16" steps.

**7** Adjust the vertical date stamp position with the **[Δ]** or **[▽]** key.

**8** Press the **[OK]** key twice.

## 5-10 Position (Page)

**Note**

- The default position and available settings of each page stamp are as follows.

◆ P1 or 1/5

Stamp positions	Default	Available settings
<p>GRPPOS0E</p>	a = 8mm, 0.32" b = 12mm, 0.48"	a = 8 – 40mm, 0.32" – 1.60" b = 8 – 40mm, 0.32" – 1.60"
<p>GRPPOS1E</p>	a = 12mm, 0.48" b = 12mm, 0.48"	

◆ -1-

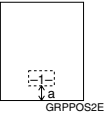
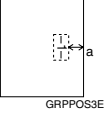
Stamp positions	Default	Available settings
	a = 8mm, 0.32"	a = 8 – 40mm, 0.32" – 1.60"
	a = 8mm, 0.32"	a = 8 – 40mm, 0.32" – 1.60"

4

**1** Press the [User Tools] key.

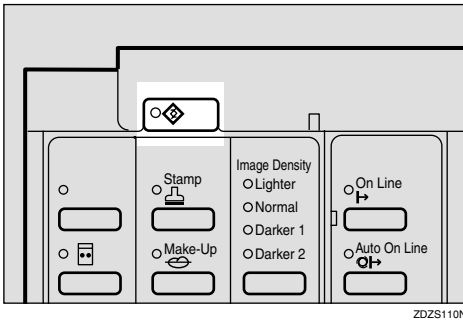

**2** Enter 5 with the number keys, and then press the [OK] or [#] key.

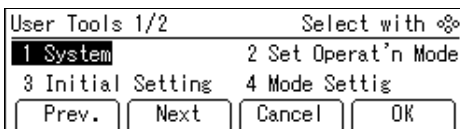

**3** Enter 10 with the number keys. Then press the [OK] or [#] key.

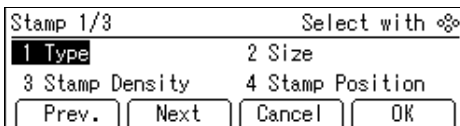

**4** Select the page numbering direction you want to adjust with the [←] [→] or [◀] [▶] keys.

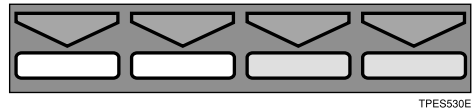
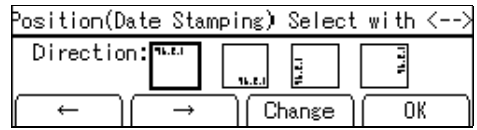

**5** Press the [Change] key.

**6** Adjust the horizontal page numbering position with the [Δ] or [▽] key, and then press the [▶] key.

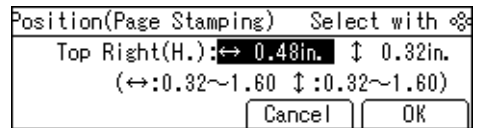

**Note**

□ The value increases or decreases in 4mm, 0.16" increments.

**7** Adjust the vertical page numbering position with the [Δ] or [▽] key.

**Note**

□ You need not follow step 7 when you select "-1-" as the direction in step 4.

**8** Press the [OK] key twice.

## 5-11 Make/Chg. Pattern

**1** Press the **[User Tools]** key.

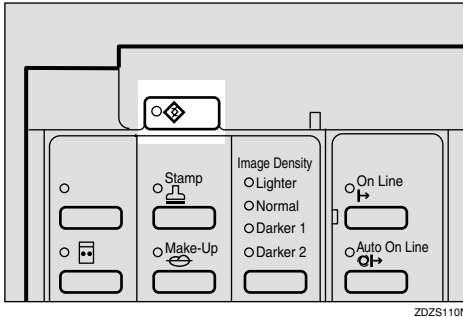

**2** Enter 5 with the number keys, and then press the **[OK]** or **[#]** key.

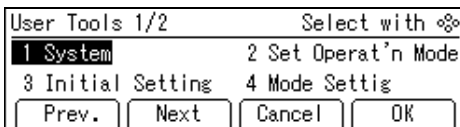

**3** Enter 11 with the number keys, and then press the **[OK]** or **[#]** key.

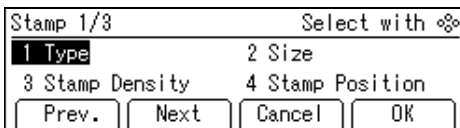

**4** Select the background pattern with the **[◀]**, **[▶]**, **[▲]**, or **[▼]** key.

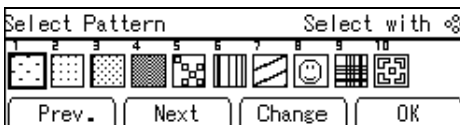

**5** Press the **[Change]** key.

**6** [Move the cursor to the position you wish to edit with the **[◀]**, **[▶]**, **[▲]**, or **[▼]** keys.]

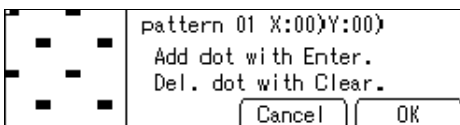

**7** Press the **[#]** or **[Clear/Stop]** key to edit the pattern.

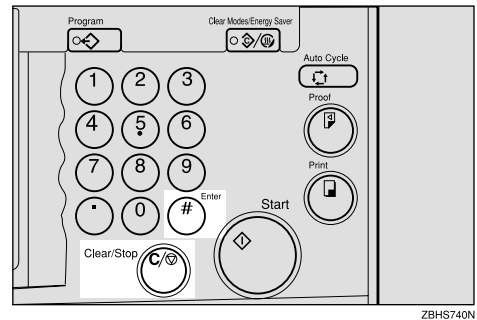

### Note

- To add a dot, press the **[#]** key.
- To remove a dot, press the **[Clear/Stop]** key.
- Repeat steps **6** and **7** until you have finished editing the pattern.

**8** Press the **[OK]** key twice.

## 6-1 Check Counter

**1** Press the **[User Tools]** key.

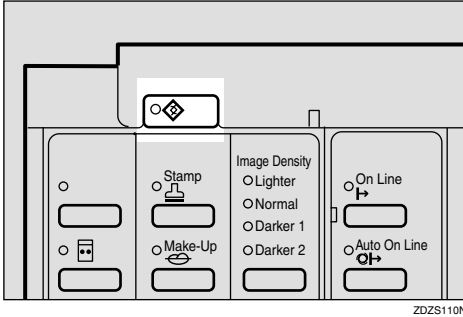

**2** Enter 6 with the number keys, and then press the **[OK]** or **[#]** key.

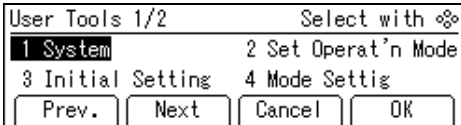

**3** Make sure that 1 is selected, and then press the **[OK]** key.

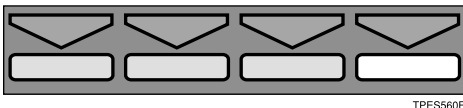
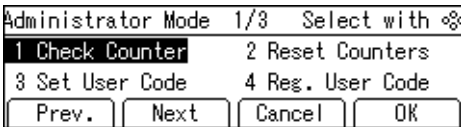

**Note**

- The number of masters and prints made under the first user code will be displayed in the panel display.

**4** Keep pressing the **[←]** or **[▶]** key to display the number of masters and prints made under your user code.

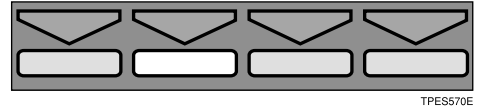
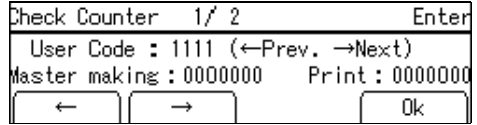

**5** Press the **[OK]** key after checking the number of masters and prints made under your user code.

## 6-2 Reset Counters

**1** Press the **[User Tools]** key.

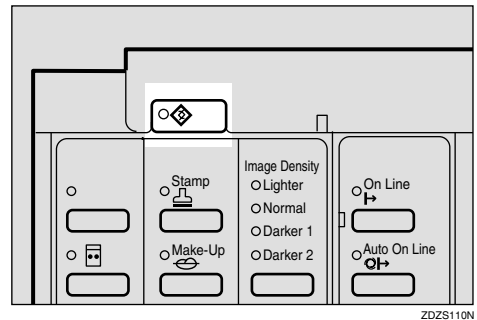

**2** Enter 6 with the number keys, and then press the **[OK]** or **[#]** key.

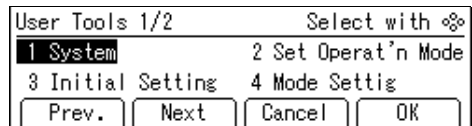



- 3** Enter 2 with the number keys, and then press the [OK] or [#] key.

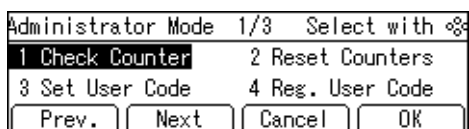

- 4** Select [Single] or [All] with the [←] [→] or [◀] [▶] keys.

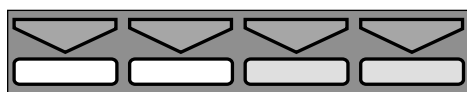
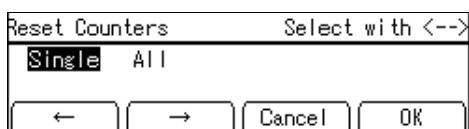

TPES50E

- 5** Press the [OK] key.

If you selected [Single]

- 1** Keep pressing the [→] or [▶] key to display the number of masters and prints made under your user code.

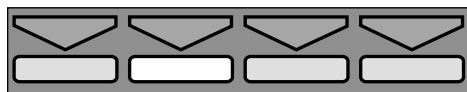
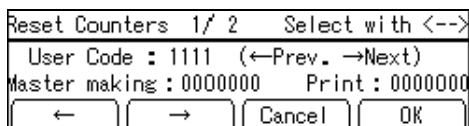

TPES570E

- 2** Press the [OK] key.  
**3** Press the [Yes] key.  
**4** Press the [Cancel] key twice.

If you selected [All]

- 1** Press the [Yes] key.

## 6-5 Chg. User Code

- 1** Press the [User Tools] key.

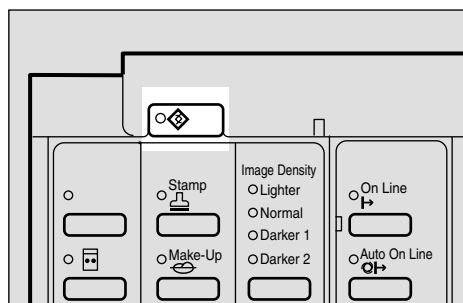

ZDZS110N

- 2** Enter 6 with the number keys, and then press the [OK] or [#] key.

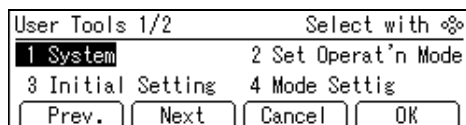

- 3** Enter 5 with the number keys, and then press the [OK] or [#] key.

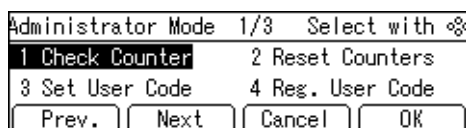

- 4** Keep pressing the [→] or [▶] key to display your user code.

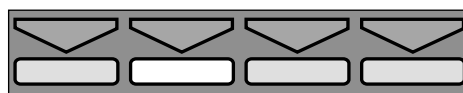
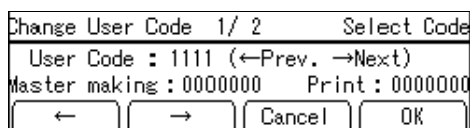

TPES570E

- 5** Press the [OK] key.

**6** Enter the new user code with the number keys.

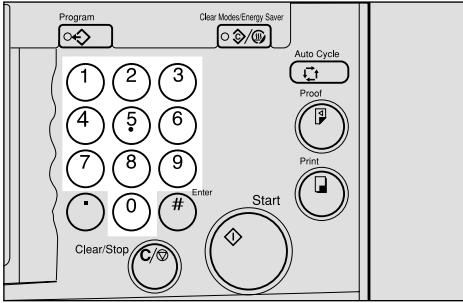

**4** Keep pressing the [→] or [▶] key to display your user code.

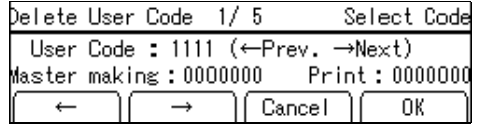

TPES570E

**7** Press the [OK] key.

**5** Press the [OK] key.

**6** Press the [Yes] key.

4

## 6-6 Del. User Code

**1** Press the [User Tools] key.

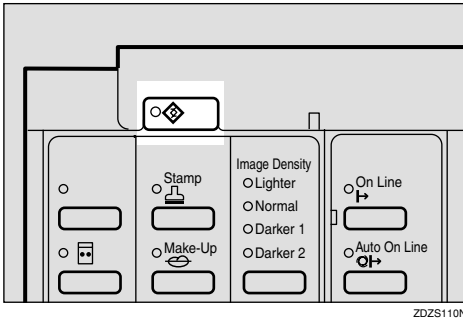

**2** Enter 6 with the number keys, and then press the [OK] or [#] key.

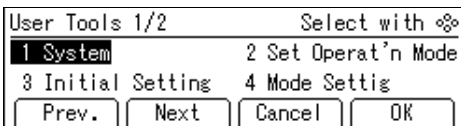

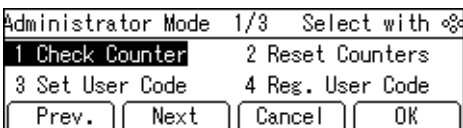

**3** Enter 6 with the number keys, and then press the [OK] or [#] key.



# 5. Troubleshooting

## If Your Machine Does Not Operate as You Want

If a malfunction or a misfeed occurs, the following messages will appear on the panel display.

Message	Meaning
Check the original direction.	The paper is not placed in the same direction as the original. Place the original in the same direction as the paper. If you press the <b>【Print】</b> key, the selected paper will be used for printing.
Size of original and paper is not the same.	Set a paper size that matches the reproduction ratio you have selected and your original. The reproduction ratio selected by Auto Magnification mode is too big or too small.  <b>Note</b> <input type="checkbox"/> You can make prints if you press the <b>【Print】</b> key.
Set original.	Make prints after confirming whether there is an original on the exposure glass. Make sure that you have changed the original on the exposure glass before pressing the <b>【Start】</b> key.
Max. quantity: ****	The number of prints exceeds the maximum print quantity. You can change the maximum number of prints that can be made in one operation with the user tools. See "Max. Quantity" on p.142 "2. Set Operat'n Mode".
Min. quantity: ****	The number of prints does not exceed the minimum print quantity. You can change the minimum number of prints that can be made in one operation with the user tools. See "Min. Quantity" on p.142 "2. Set Operat'n Mode".
Drum unit is not set. Set Drum unit.	Slide in the drum until it clicks. Make sure that the drum is completely set in position.
Communication error Turn the main switch off then on	Turn the main switch off and on. If the message appears again, contact your service representative.
Overloaded for the delivery tray Please remove the paper	Remove the paper from the delivery tray.  <b>Reference</b> See "Delivery Capacity" on p.142 "2. Set Operat'n Mode".

Message	Meaning
<p>Print image is larger than the selected paper size. Change the paper size.</p>	<p>The master image previously printed is larger than the paper, the image exceeds the paper size. Make prints again after pressing the <b>[Exit]</b> key and selecting the paper size again.</p> <p> <b>Note</b></p> <ul style="list-style-type: none"> <li><input type="checkbox"/> If you press the <b>[Exit]</b> key to erase the message and press the <b>[Print]</b> key, the machine starts to make the prints. However, the image might not fit on the paper.</li> </ul>

 **When a service call message is shown on the panel display**

Press the **[Exit]** key. Then turn the main switch off and back on again. If a service code appears again, contact your service representative.

 **Note**

- If a service code appears on the panel display after you turn the main switch off and on a few times, do not continue turning it on and off. Leave the machine off.
- When you make masters continuously using originals with solid images, “SC-03-03” tends to appear on the panel display. In this case, turn off the main switch and wait for a while. Then turn on the main switch.

5

## If You Cannot Make Prints as You Want

Problem	Cause	Action
Misfeeds occur frequently.	Improper paper type is selected.	Select proper paper type. See p.43 "Printing onto Various Kinds of Paper".
When you try to set several functions at a time, you cannot set some functions.	Some functions cannot be used together.	See p.135 "Combination Chart".
Parts of the image are not printed in Edge Erase mode.	Erase margin is too wide.	Set a narrower erase margin with the user tools. See p.155 "3-11 Margin Erase Area".
	Edge margins of original are too narrow.	
Prints are blank or parts of the image are not printed.	The paper feed side plates are not set correctly.	Make sure that the paper feed side plates touch the paper lightly and the proper paper size is displayed in the panel display.
2nd printing with another drum is unsatisfactory.	The 1st print image is still wet.	Wait until the 1st image becomes dry.
An uneven solid image appears.	Large solid image wrinkles the master.	Increase the print speed or select photo mode.

## Combine Originals Mode

Problem	Cause	Action
Prints are blank or parts of the image are not printed.	Original size and direction are not correct.	You cannot use originals of different sizes and directions in Combine Originals mode. Use originals of same size and direction.
Print image is not correct.	Original set order is not correct.	Place originals face up in the optional document feeder. The first original should be on top.
		Place original face down on the exposure glass. The first original should be set first.

# Loading Paper

The **Load Paper** indicator (🖨️) lights when the paper feed tray runs out of paper.

⚠️ **Limitation**

- ❑ Load paper when the paper feed tray is completely empty. If you add paper when some paper is left in the tray, it may cause multiple feeds or misfeeds.

🔍 **Reference**

For available paper sizes, see p.11 "Print Paper".

5

- 1 Load the paper in the paper feed tray.

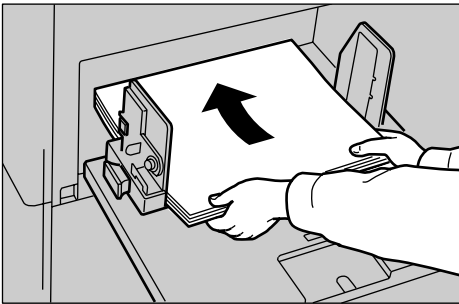

- 2 Adjust the paper feed side plates to match the paper size.

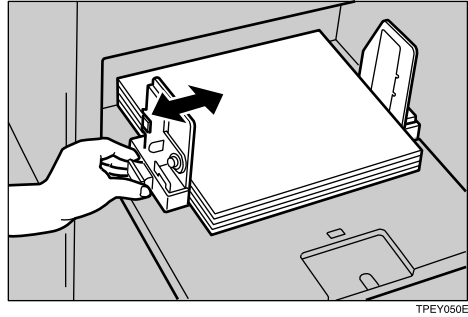

📌 **Note**

- ❑ Make sure that the paper size and direction shown on the panel display match the size and direction of paper loaded in the paper feed tray.

# Clearing Misfeeds

**CAUTION:**

- Be careful not to cut yourself on any sharp edges when you reach inside the machine to remove misfed sheets of paper or masters.

**Note**

- ❑ After clearing misfeeds, make sure that all the doors, covers, and units are closed and the indicator is off.
- ❑ To prevent misfeeds, do not leave any torn scraps of paper, originals, or masters in the machine.
- ❑ When clearing misfeeds, do not turn off the main switch. If you do, your print settings will be cleared.
- ❑ If misfeeds occur repeatedly, please contact your service representative.

## " + A " Paper Misfeeds in the Paper Feed Section

- 1 Remove the misfed paper.

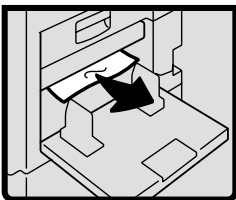

**To prevent paper misfeeds:**

Check the following before restarting the printing run.

- Did you select an appropriate paper type with the [Ppr.Type] key?

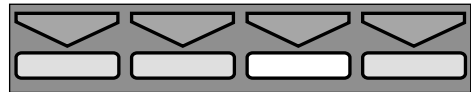

- Are the side pads in the correct positions?

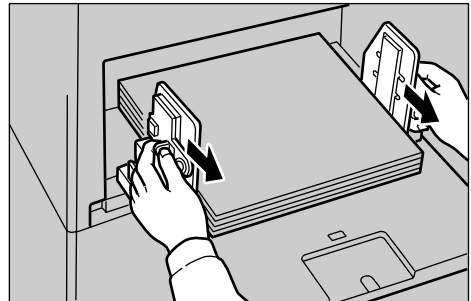

To print on thin paper (47.1g/m<sup>2</sup>, 12.5 lb), slide the levers behind the paper feed side plates in the direction of the arrow (see illustration).

- When paper is curled, correct as shown.

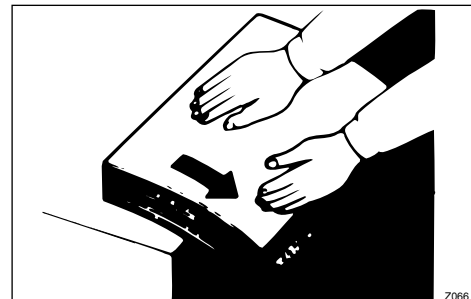

- When paper edges stick together or paper is not fed in, fan the paper as shown.

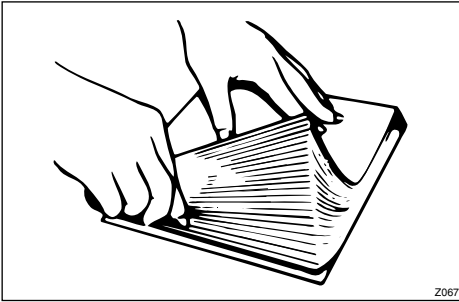

- When printing onto postcards or thick paper, lower the printing speed to setting 1 or 2. See p.27 “Changing the Printing Speed”.

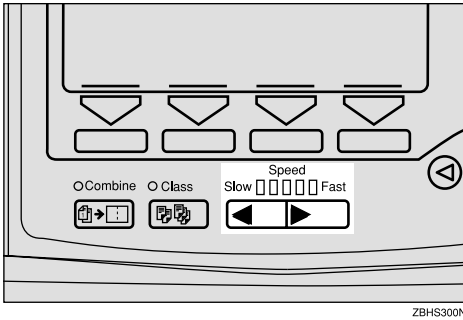

- When a multiple feed occurs or the paper comes out skewed, make sure that the paper feed side plates are properly adjusted. When you load paper on the paper feed tray, make sure that the paper edge touches the back fence and paper is placed on the proper paper size scale. Only use paper where the leading edge has two right angle corners.



## ”R + A + B” Paper Misfeeds in the Paper Feed Section

- 1 Open the front door.
- 2 Lower drum unit lock lever (B1).

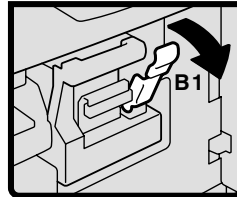

- 3 Take out the drum.

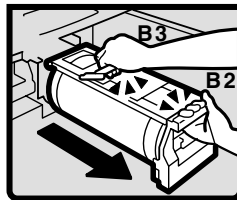
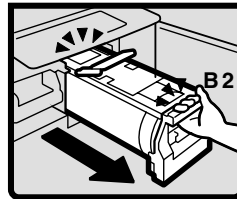

**Note**

- For taking out the drum unit, see p.130 “Changing the Color Drum Unit”.

- 4 Gently pull out the misfed paper from the inside.

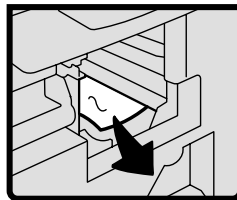



- 5** If you cannot remove the misfed paper, remove it from the paper feed tray.

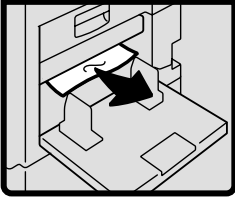

- 6** Set the drum unit and close the front door.

**Note**

- For setting the drum unit, see p.130 "Changing the Color Drum Unit".

**To prevent paper misfeeds:**

See p.171 " + A" Paper Misfeeds in the Paper Feed Section".

**" + B" Paper or Master  
Wrapped Around the Drum**

When the master is wrapped around the drum

- 1** Open the front door.
- 2** Lower drum unit lock lever (B1).

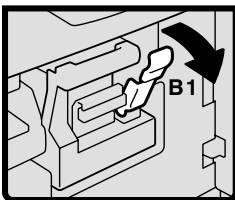

- 3** Take out the drum.

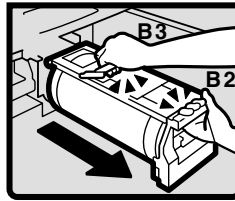
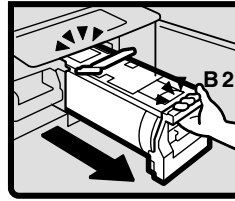

**Note**

- For taking out the drum unit, see p.130 "Changing the Color Drum Unit".

- 4** While pressing the drum lock, grasp the edge of the master (the white area) and peel it off.

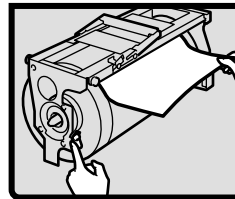

- 5** Return the drum lock to its original position.

- 6** Set the drum unit and close the front door.

**Note**

- For setting the drum unit, see p.130 "Changing the Color Drum Unit".

When paper is wrapped around the drum

- 1** Open the front cover.

**2** Lower drum unit lock lever (B1).

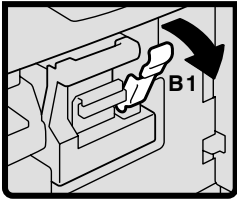

**3** Take out the drum.

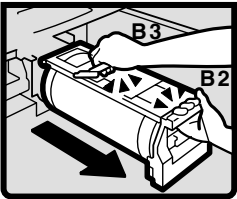
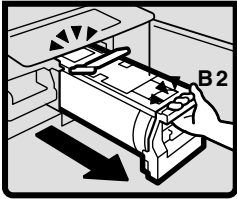

**Note**

□ For taking out the drum unit, see p.130 "Changing the Color Drum Unit".

**4** Remove the misfed paper from the drum.

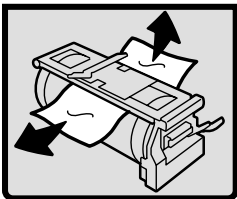

**5** If you cannot find misfed paper around the drum (as in step 4), check the pressure cylinder. Remove any misfed paper.

**6** Set the drum unit and close the front door.

**Note**

□ For setting the drum unit, see p.130 "Changing the Color Drum Unit".

**When paper is misfed inside the machine**

**1** Open the front cover.

**2** Lower drum unit lock lever (B1).

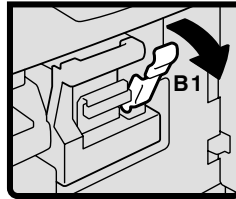

**3** Take out the drum.

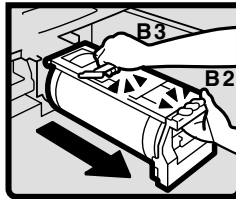
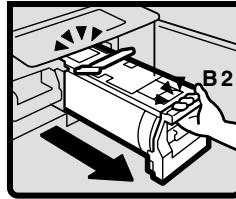

**Note**

□ For taking out the drum unit, see p.130 "Changing the Color Drum Unit".

**4** Remove the misfed paper from the inside as shown in the illustration.

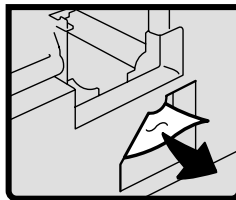

**5** If you cannot remove the misfed paper, remove paper from the pressure cylinder.

- 6 Set the drum unit and close the front door.

**Note**

- For setting the drum unit, see p.130 "Changing the Color Drum Unit".

**To prevent paper misfeeds:**

If the paper is curled or the original's leading edge margin is too narrow, the following action is necessary.

- When you use curled paper, correct as shown.

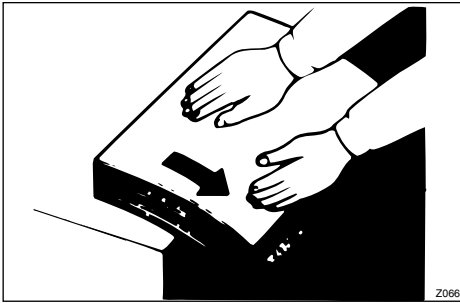

- When the leading edge margin of the original is less than 8mm, 0.32" or there is a solid image on the leading edge, insert the original with the widest margin first or make a leading edge margin by making a copy.

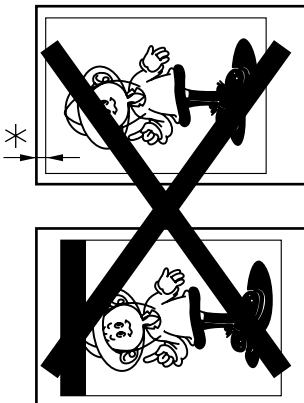

\* Less than 8mm, 0.32"

## "R + C" Paper Misfeeds in the Paper Exit Section

- 1 Slowly, but firmly pull out the misfed paper.

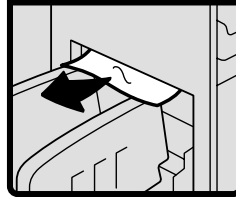

**To prevent paper misfeeds:**

When thin paper misfeeds in the paper exit section, reduce the printing speed with the [◀][▶][Speed] keys. See p.27 "Changing the Printing Speed". If you cannot reduce the printing speed, close the trailing edge guides or move the end plate toward the paper delivery tray edge.

## ”⌘ + D” Master Misfeeds in the Master Feed Section

**1** Pull out the master tray until it stops.

**2** Open the master guide.

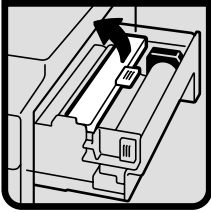

**3** Open the master tray cover (1).

**4** Remove the master roll (2).

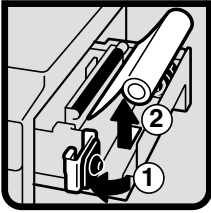

**5** Reset the master roll (1).

**Note**

□ The master roll must be positioned as shown in the illustration in step 6.

**6** Close the master tray cover (2).

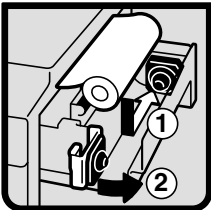

**7** Position the master roll so that the edge reaches the interior of the master holder.

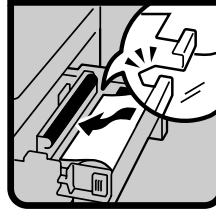

**8** Close the master guide.

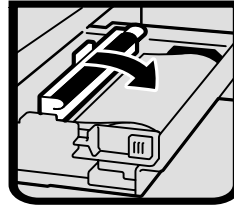

**9** Push in the master tray until it stops.

## ”⌘ + D + B” Master Misfeeds in the Master Feed Section

**1** Open the front door.

**2** Lower drum unit look lever (B1).

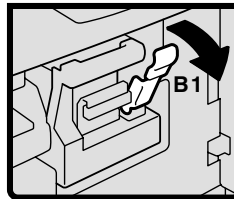

**3** Take out the drum.

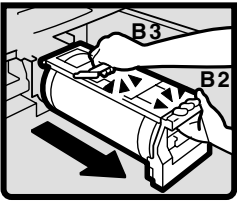
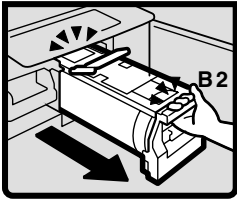

**Note**

□ For taking out the drum unit, see p.130 "Changing the Color Drum Unit".

**4** Pull out the misfed master from inside.

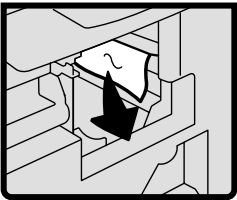

**5** Set the drum unit and close the front door.

**Note**

□ For setting the drum unit, see p.130 "Changing the Color Drum Unit".

## "B + E" Master Misfeeds in the Master Eject Section

**1** Open the front door.

**2** Lower drum unit lock lever (B1).

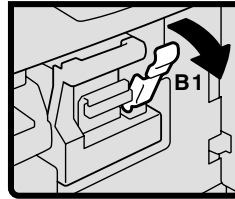

**3** Take out the drum.

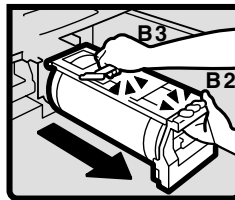
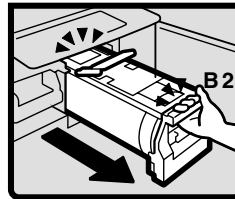

**Note**

□ For taking out the drum unit, see p.130 "Changing the Color Drum Unit".

**4** Grasp handle (E1) and pull out the master eject unit until it stops.

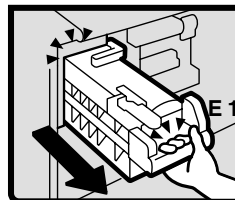

- 5** Pull out lever (E3) and remove the misfed master.

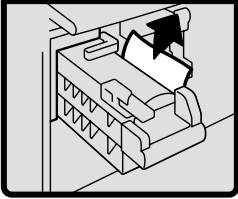
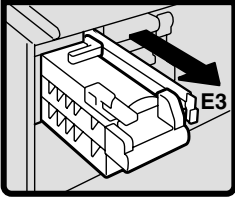

- 6** Return lever (E3) and the master eject unit to their original positions.

- 7** Set the drum unit and close the front door.

**Note**

- For setting the drum unit, see p.130 "Changing the Color Drum Unit".

## "8r + E" Master Misfeeds in the Master Eject Section

- 1** Open the front door.
- 2** Grasp handle (E1) and pull out the master eject unit until it stops.

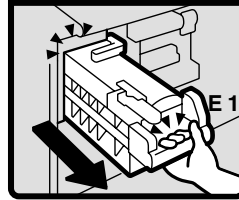

- 3** Check where the misfed master is. Remove the misfed master.

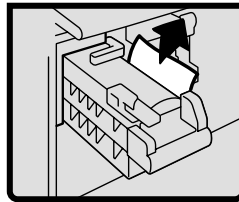

- 4** Return the master eject unit to its original position and close the front door.

**💡 If master misfeeds occur often**

If the master misfeeds often, fragments of the master might be left in the bottom of the master tray. Remove the fragments.

**1 Slide out the master tray.**

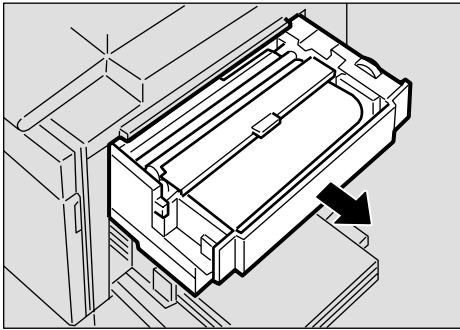

ZADH180E

**2 Open the cover at the bottom of the master tray while holding the lever and remove the fragments.**

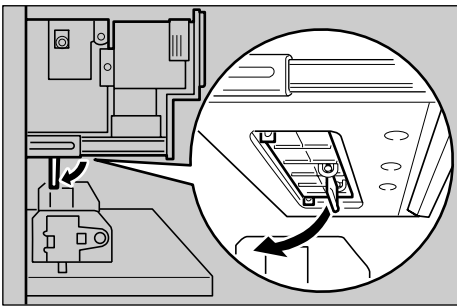

ZFXH201N

**3 Close the black cover and slide in the master tray.**

**Note**

- Make sure that you securely close the black cover before sliding in the master tray.

**”P” Original Misfeeds Occur When Using the Optional Document Feeder**

**1 Open the document feeder (ADF) cover.**

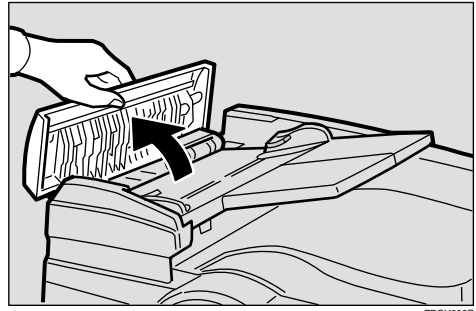

ZDCY090E

**2 Pull out the misfed original gently.**

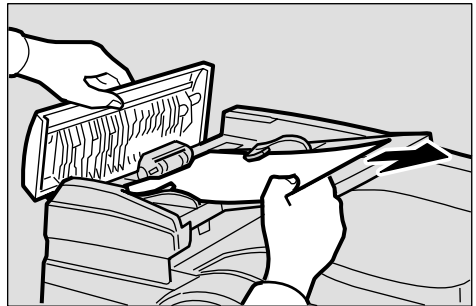

ZDCY120E

**3 If you cannot remove misfed originals as in step 2, open the document feeder.**

**4 Pull the green knob towards you and remove the misfed original.**

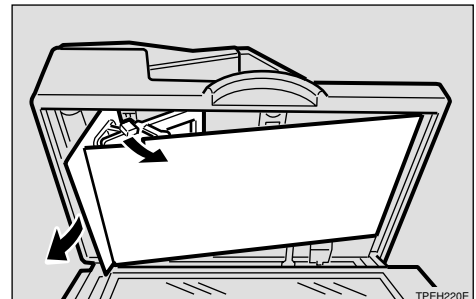

TPEH220E

**5** Return the document feed sheet to its original position.

**6** Close the document feeder (ADF) cover until it clicks in position and if necessary, close the document feeder.

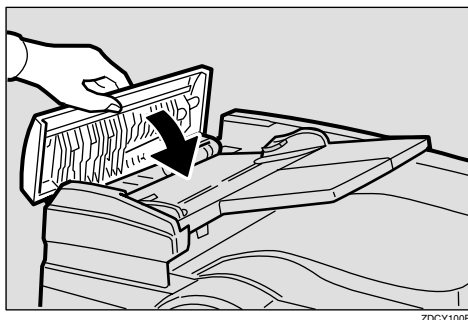

5

**💡 To prevent originals misfeeding:**

Placing the following kinds of originals on the exposure glass may cause misfeeds.

- Originals heavier than 128g/m<sup>2</sup>, 34 lb
- Originals lighter than 52g/m<sup>2</sup>, 14 lb
- Originals smaller than 148mm × 210mm, 5.9" × 8.3"
- Originals larger than 297mm × 864mm, 11.6" × 34.0"
- Stapled or clipped originals
- Perforated or torn originals
- Curled, folded, or creased originals
- Originals with any kind of coating, such as thermal fax paper, art paper, aluminum foil, carbon paper, or conductive paper
- Bound originals such as books
- Damaged originals
- Originals with glue on them
- Pasted originals

- Originals written in pencil
- Thin originals that have low stiffness
- Originals with index tabs
- Transparent originals such as OHP transparencies or translucent paper

**📎 Note**

- Do not mix different sizes of originals in the optional document feeder.
- Remove staples or paperclips from originals. Fan originals that have had staples or paperclips removed.
- Do not stack originals above the limit mark.



# When the Open Cover/Unit Indicator ( ) Lights

 Make sure that the following doors/covers are closed.

## ❖ Front door

Close the front door completely.

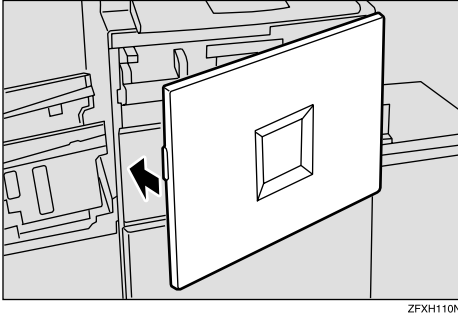

## ❖ Optional document feeder (ADF) cover

Close the document feeder (ADF) cover until it locks in position.

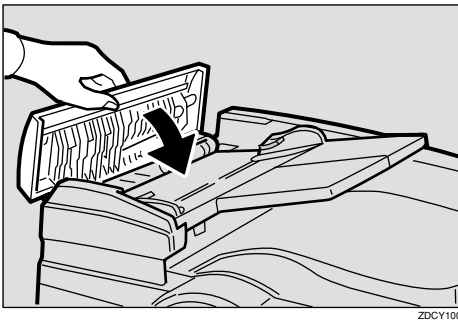

## When the Add Ink Indicator (🖨️) Lights

The **Add Ink** indicator (🖨️) lights when it is time to supply ink.

**⚠️ CAUTION:**

- *If ink comes into contact with your eyes, rinse immediately in running water. For other symptoms, consult a doctor.*

**⚠️ CAUTION:**

- *Keep the ink or ink container out of reach of children.*

**⚠️ CAUTION:**

- *If ink is ingested, induce vomiting by drinking a strong saline solution. Consult a doctor immediately.*

**⚠️ CAUTION:**

- *Our products are engineered to meet high standards of quality and functionality, and we recommend that you use only the expendable supplies available at an authorized dealer.*

5

**🔧 Note**

- Be sure to supply ink of the same color as the current drum.
- Ink is easily removed from skin by waterless hand cleaners followed by washing with soap and water.
- Be careful not to get any ink on your clothing.
- Store ink under low temperature and humidity conditions.
- Do not store ink where it will be exposed to heat or direct sunlight.
- Store on a flat surface.

**1** Open the front door.

**2** Pull out the ink holder.

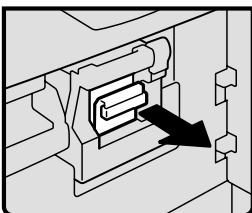

- 3** Remove the used ink cartridge.

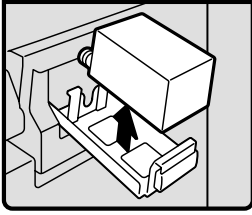

- 4** Remove the cap of the new ink cartridge.

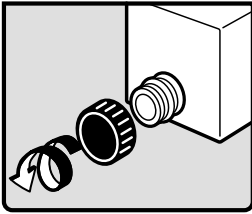

- 5** Insert the new cartridge into the ink holder.

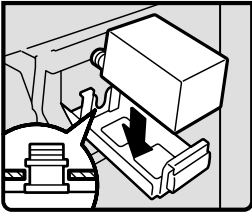

 **Note**

- Always supply ink of the same color.

- 6** Return the ink holder to its original position until it clicks.

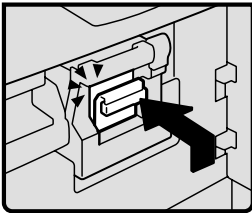

- 7** Close the front door.

The machine will start idling to supply ink to the drum.

# When the Master End Indicator (📊) Lights

The **Master End** indicator (📊) lights when it is time to replace the master roll or when you need to set the master roll.

**⚠ CAUTION:**

- *Our products are engineered to meet high standards of quality and functionality, and we recommend that you use only the expendable supplies available at an authorized dealer.*

**1** Pull out the master tray until it stops.

**2** Open the master guide.



**3** Open the master tray cover (1).

**4** Remove the used master roll (2).

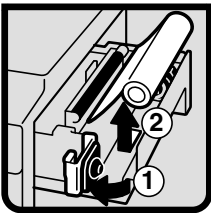

**Note**

- When the **Master End** indicator is lit, it is necessary to replace the master roll even if some master remains on the old roll.

**5** The new master roll must be positioned as shown in the illustration (1).

**6** Close the master tray cover (2).

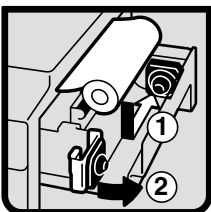

- 7** Position the master roll so that the edge reaches the interior of the master holder.

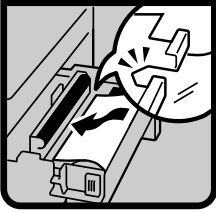

- 8** Close the master guide.

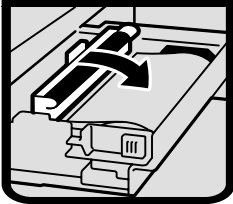

- 9** Push in the master feed unit until it stops.

# When the Master Eject Indicator (🔒) Lights

The **Master Eject** indicator (🔒) lights when it is time to empty the master eject unit or when you need to set the master eject unit.

**Note**

- ❑ Ink is easily removed from skin by waterless hand cleaners followed by washing with soap and water.
- ❑ Be careful not to get any ink on your clothing while emptying the master eject unit.

**1** Prepare a container for the used master.

**2** Open the front door.

**3** Use handle (E1) to pull out the master eject unit until it stops.

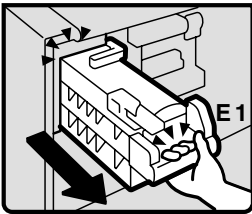

**4** Pull up handle (E2) and pull out the master eject unit completely.

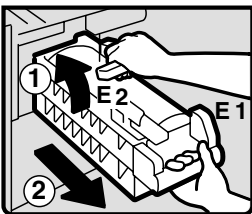

**5** Hold the master eject unit upper handle and turn it clockwise with one hand while holding handle (E1) with other hand (1).

**6** Remove the used master by pushing down the handle (1) towards the waste container (2).

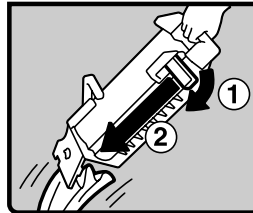

**Note**







- ❑ If you cannot remove the used master completely, repeat step **6** until all the master is removed.

**7** Reinstall the master eject unit, making sure it clicks into position.

**8** Close the front cover.

5

# When Other Indicators Are Lit

Indicator	Meaning and action
 <small>TPES270E</small>	The key counter (option) is not set. Insert the key counter.
<ul style="list-style-type: none"> <li data-bbox="152 426 471 542">• (Metric version)    <small>TPES280E</small> </li> <li data-bbox="152 542 471 678">• (Inch version)    <small>TPES280N</small> </li> </ul>	Color drum unit is installed.
<ul style="list-style-type: none"> <li data-bbox="152 683 471 799">• (Metric version)    <small>TPES290E</small> </li> <li data-bbox="152 799 471 935">• (Inch version)    <small>TPES290N</small> </li> </ul>	A3/11" × 17" drum unit is set.
<ul style="list-style-type: none"> <li data-bbox="152 940 471 1056">• (Metric version)    <small>TPES300E</small> </li> <li data-bbox="152 1056 471 1192">• (Inch version)    <small>TPES300N</small> </li> </ul>	A4/8 <sup>1</sup> / <sub>2</sub> " × 11" drum unit is set.

# When Prints Are Not Delivered in a Neat Stack

## When Printing on Small Size Paper

**1** Adjust the angle of the end plate by turning the screw clockwise or counterclockwise.

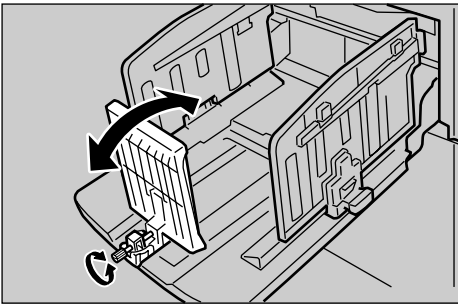

ZDCH150E

**Note**

- Make sure that the paper size and direction in the panel display match the actual paper size and direction of the paper on the feed tray.
- If the paper on the paper feed tray has a solid image on its back side, the machine may not be able to detect the size correctly. Place a sheet of paper of the same size without an image on the back at the bottom of the paper stack.

## When the Machine Cannot Detect the Paper Size

If the paper size is not detected correctly when printing, prints might not be delivered in a neat stack. To solve this, do one of the following:

**1** Re-adjust the paper feed side plates so that there is no space between the side plates and the paper, and then lock the side plates in position.

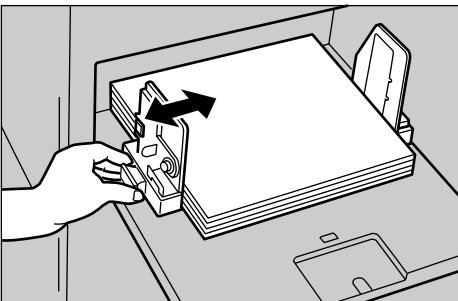

TPEY050E



# Poor Printing

## Dirty Background

If the background of prints is dirty, the drum unit might be dirty.

**⚠ CAUTION:**

- *If ink comes into contact with your eyes, rinse immediately in running water. For other symptoms, consult a doctor.*

**⚠ CAUTION:**

- *Keep the ink or ink container out of reach of children.*

**⚠ CAUTION:**

- *If ink is ingested, induce vomiting by drinking a strong saline solution. Consult a doctor immediately.*

**📌 Note**

- ❑ To avoid getting dirty background prints when printing onto paper smaller than the original image, select a suitable reduction ratio or use larger print paper.
- ❑ When printing onto paper that does not absorb ink well, like postcards, the background of prints might be dirty. In this case, lower the printing speed or use Skip Feed mode to dry the ink on the prints.

**1 Turn off the main switch.**

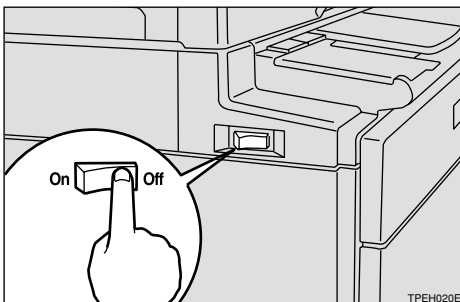

**2** Pull out the drum unit.

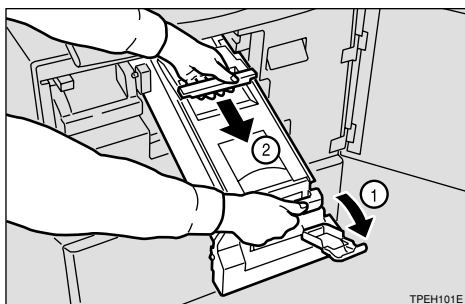

**Note**

□ For taking out the drum unit, see p.130 “Changing the Color Drum Unit”.

**3** While pressing the drum lock, turn the drum until you can see the trailing edge of the master.

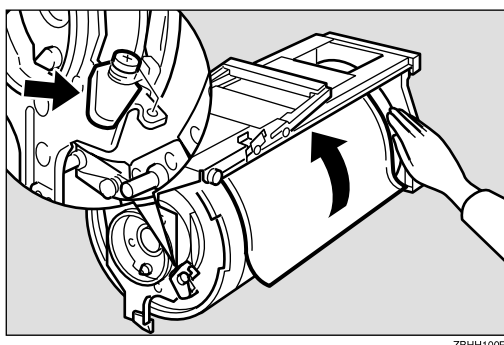

5

**4** With a dry soft cloth, remove any ink that has accumulated on the trailing edge of the drum unit.

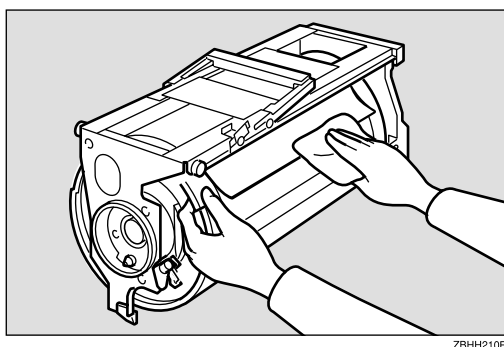

**Important**

□ Do not use benzene, thinner, or other organic liquids—doing so can damage the machine.

- 5** Turn the drum unit and lock it after cleaning.

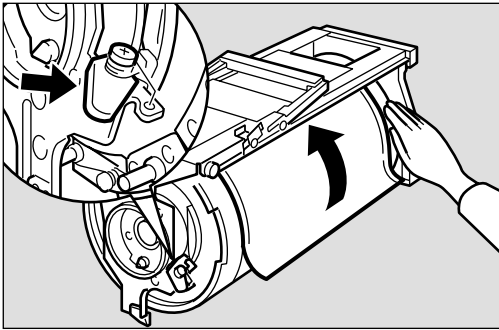

ZBHH100E

- 6** Insert the drum unit until it locks into position, and then lower the drum unit lock lever.

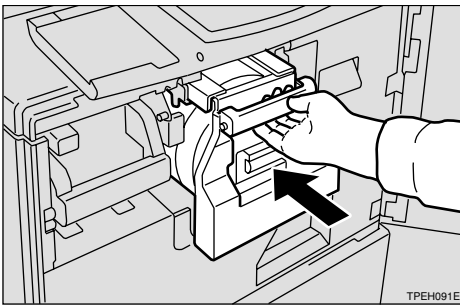

TPEH091E

- 7** Close the front door.

- 8** Turn on the main switch.

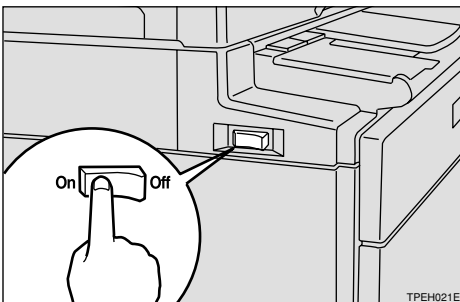

TPEH021E

---

## Black Lines/Stained Prints

---

Check the platen cover and clean it if dirty. See p.197 "Cleaning the platen cover".

Check the exposure glass and clean it if dirty. See p.197 "Cleaning the exposure glass".

Check the sheet of the optional document feeder and clean it if dirty. See p.198 "Cleaning the Sheet".

### **Note**

- If black lines or stains still appear on prints even following the cleaning procedures above, please contact your service representative.

---

## Faint Prints

---

5

If the machine is not used for a long period of time or you change the color drum unit, the ink on the drum might dry causing print quality to deteriorate. To solve this problem, use Quality Start mode. See p.76 "Quality Start Mode".

If the print density is still too light even if you use Quality Start mode, remake the master.

## Do's and Don'ts

### **CAUTION:**

- *Unplug the power cord from the wall outlet before you move the machine. While moving the machine, you should take care that the power cord will not be damaged under the machine.*

### **Important**

- Make sure that the  indicator on the PC controller operation panel is off before unplugging the power cord.
- While printing, do not turn off the main switch.
- While printing, do not unplug the power cord.
- While printing, do not open the door or covers.
- While printing, do not move the machine.
- Open and close all doors and covers carefully.
- When printing onto paper that contains images on the back, make sure there is a 10mm (0.4") margin at the back leading edge. If there is no margin, the machine might wrongly detect that paper is wrapped around the drum and stop printing.
- When you use envelopes or pasted print paper, the leading edge of the prints might be damaged.
- Always make a few trial prints to check the image position because the image position of the trial print might not correspond with that of the original.
- The leading edge of the prints might become stained if the edge touches the image of prints on the paper delivery tray.
- Print ink on the paper delivery tray might stick to the back side of the next print.
- Press the **【Proof】** key to perform a test print as the image density of the first few prints might be light.
- When the machine is on and the power source is less than 90% of the specified amount, printing quality will decrease. Therefore, make sure the supply from your electrical outlet is at least 90% of the required amount.
- When you make a lot of prints from a small image, ink might ooze out from the edges of the master, especially in high temperatures and when printing in two or more colors. In these cases, make a new master.
- Remove the paper from the tray before relocating the machine. If you relocate the machine leaving the paper on the tray, reset the paper after the relocation. If the main switch of the machine is turned on without resetting the paper correctly, the sensor might be broken.

- If the printed paper is stored for more than one day, the paper may become wrinkled. If this paper is used, wrinkles may also appear on the master. If the paper will be stored for more than one day, store it in its original wrapping paper or other protective covering.
- Shadowing may occur if the printed image at the rear edge of the paper is a solid color, when the printing speed is set to 1. If this occurs, print the image with the printing speed set to 3.
- If there are fine lines within 5mm to 10mm, 0.2" to 0.4" of the edge of the image, shadowing may occur.
- Depending on the type of paper being used, speckles may appear within 5mm to 10mm, 0.2" to 0.4" of the edge of the image at around 1000 prints.
- When two or more sheets of paper feed at once, set paper on the paper feed side plates securely. See p.15 "Printing Preparations".
- When paper misfeeds occur, select the proper paper type from **[Ppr.Type]**. See p.43 "Printing onto Various Kinds of Paper". If the problem persists, fan or turn the paper over.
- If the paper skews, make sure to set the paper feed side plates securely. See p.15 "Printing Preparations".
- Make sure originals on the exposure glass are correctly positioned and aligned with the scale.
- If the edges of the paper are rounded, skewing might occur. Change the paper's orientation or replace.
- If the paper becomes creased, make sure the correct paper type has been selected **[Ppr.Type]**. See p.43 "Printing onto Various Kinds of Paper".
- If non-standard papers crease frequently, use the standard paper type.

---

# Where to Put Your Machine

---

---

## Environment

---

Your machine's location should be carefully chosen because environmental conditions greatly affect its performance.

---

---

### Optimum environmental conditions

---

**⚠ CAUTION:**

- *Keep the machine away from humidity and dust. Otherwise a fire or an electric shock might occur.*
- *Do not place the machine on an unstable or tilted surface. If it topples over, an injury might occur.*

**⚠ CAUTION:**

- *If you use the machine in a confined space, make sure there is a continuous air turnover.*

**⚠ CAUTION:**

- *After you move the machine, use the caster fixture to fix it in place. Otherwise the machine might move or come down to cause an injury.*

- Temperature: 10 – 30°C, 50 – 86°F
- Humidity: 20 – 90% RH
- A strong and level floor.
- The machine must be level within 5mm, 0.2" both front to rear and left to right.

---

### Environments to avoid

---

- Locations exposed to direct sunlight or strong light (more than 1500 lux).
- Locations directly exposed to cool air from an air conditioner or heated air from a heater (sudden temperature changes might cause condensation within the machine).
- Places where the machine might be subjected to frequent strong vibration.
- Dusty areas.
- Areas with corrosive gases.

## Power Connection

**⚠ WARNING:**

- **Connect the machine only to the power source described on the inside front cover of this manual. Connect the power cord directly into a wall outlet and do not use an extension cord.**
- **Do not damage, break or make any modifications to the power cord. Do not place heavy objects on it. Do not pull it hard nor bend it more than necessary. These actions could cause an electric shock or fire.**

**⚠ CAUTION:**

- *Unplug the power cord from the wall outlet before you move the machine. While moving the machine, you should take care that the power cord will not be damaged under the machine.*

**⚠ CAUTION:**

- *When you disconnect the power plug from the wall outlet, always pull the plug (not the cable).*

Make sure the plug is firmly inserted in the outlet.

6

## Machine Clearance

Place the machine near the power source, providing clearance as shown.

◆ **Main frame**

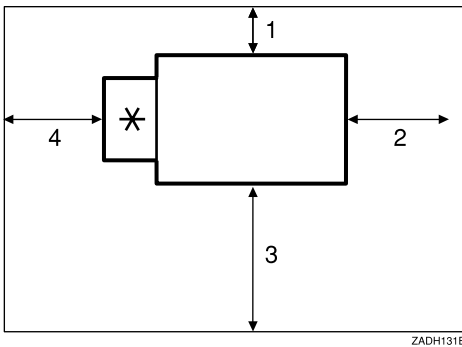

\* Paper delivery tray

1. More than 10cm, 4.0"
2. More than 60cm, 23.7"
3. More than 60cm, 23.7"
4. More than 60cm, 23.7"



# Maintaining Your Machine

To maintain high print quality, clean the following parts and units regularly.

## ❖ Cleaning the machine

Wipe the machine with a soft, damp cloth. Then wipe it with a dry cloth to remove the water.

## ⚠ Important

- ❑ Do not use chemical cleaner or organic solvents, such as thinner or benzene. If they get into the machine or melt plastic parts, a failure might occur.
- ❑ Do not clean parts other than those specified in this manual. Such parts should be cleaned by your service representative.

## Cleaning the Main Frame

### Cleaning the exposure glass

- 1** Lift the platen cover or document feeder.
- 2** Clean ① and ②.

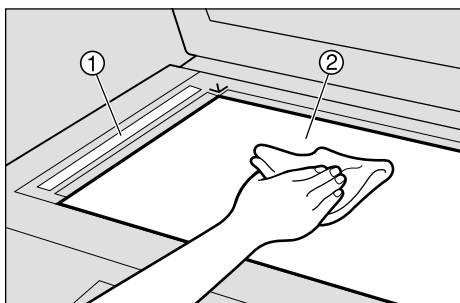

ZDCH130E

### Cleaning the platen cover

- 1** Lift the platen cover.
- 2** Clean the platen cover with a damp cloth and wipe it with a dry cloth.

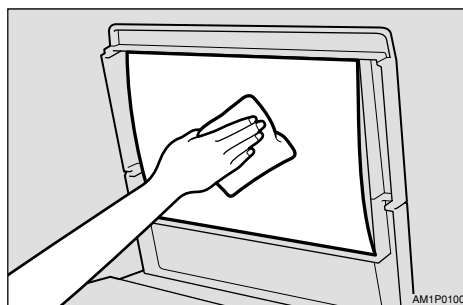

AM1P0100

### ✎ Note

- ❑ If you do not clean the platen cover, marks on the cover will be printed.

### Cleaning the paper feed roller (Paper feed tray)

- 1** Wipe dust off the paper feed roller with a damp cloth, and then wipe it with a dry cloth.

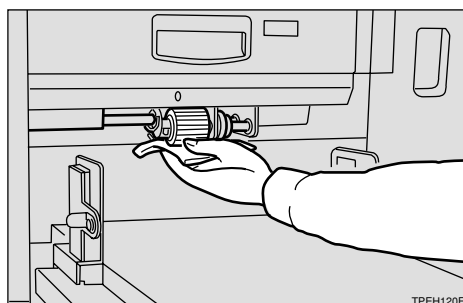

TPEH120E

### ✎ Note

- ❑ If you do not clean the paper feed roller, paper misfeeds tend to occur.

---

## Cleaning the Optional Document Feeder

---

---

### Cleaning the Sheet

---

- 1** Lift the document feeder.
- 2** Clean the sheet with a damp cloth and wipe it with a dry cloth.

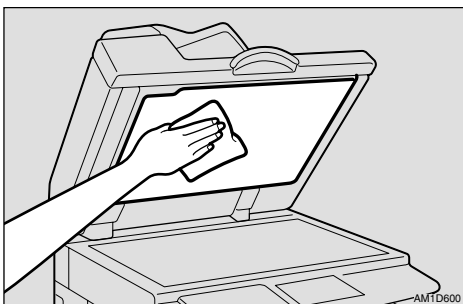

**Note**

- If you do not clean the sheet, marks on the sheet will be printed.

# 7. Specifications

## Main Frame

- ❖ **Configuration:**  
Floor standing (with custom table or cabinet).
- ❖ **Printing Process:**  
Full automatic one drum system
- ❖ **Original Type:**  
Sheet/Book
- ❖ **Original Size:**  
Maximum 305mm × 432mm, 12.0" × 17.0"
- ❖ **Pixel Density:**  
400dpi
- ❖ **Image Mode:**  
Photo mode  
Letter mode  
Letter/Photo mode  
Pencil mode  
Tint mode
- ❖ **Reduction Ratios:**
  - Inch version:  
93%, 77%, 74%, 65%
  - Metric version:  
93%, 87%, 82%, 71%
- ❖ **Enlargement Ratios:**
  - Inch version:  
155%, 129%, 121%
  - Metric version:  
141%, 122%, 115%
- ❖ **Zoom:**  
From 50% to 200% in 1% steps
- ❖ **Directional Magnification:**
  - Vertical:  
From 50% to 200% in 1% steps
  - Horizontal:  
From 50% to 200% in 1% steps

❖ **Printing Area:**

- A3 drum:
  - Inch version: More than 290 × 420mm, 11.4" × 16.5"
  - Metric version: More than 290mm × 410mm, 11.4" × 16.1"
- A4 drum:  
More than 290mm × 200mm, 11.4" × 7.8"

❖ **Print Paper Size:**

Maximum recommended: 297mm × 432mm, 11.6" × 17.0" (Maximum: 320mm × 447mm, 12.6" × 17.6")

Minimum: 70mm × 148mm, 2.8" × 5.8"

❖ **Leading Edge Margin:**

Less than 8mm, 0.32"

❖ **Print Paper Weight:**

- 47.1 – 209.3g/m<sup>2</sup>, 12.5 – 55.6 lb

❖ **Print Speed:**

60 – 120rpm (5 steps)

❖ **First Copy Time (Master Process Time):**

Less than 16 seconds (A3, 11" × 17" )

Less than 12 seconds (A4, 8<sup>1</sup>/<sub>2</sub>" × 11" )

❖ **Second Copy Time (First Print Time):**

Less than 19 seconds (A3, 11" × 17")

Less than 15 seconds (A4, 8<sup>1</sup>/<sub>2</sub>" × 11")

❖ **Color Printing:**

Drum unit replacement system

❖ **Image Position:**

- Vertical:
  - Inch version: ± 10mm, ± 0.4"
  - Metric version: ± 15mm, ± 0.6"
- Side:  
± 10mm, ± 0.4" (for either side)

❖ **Paper Size and Paper Capacity:**

1,000 sheets (80g/m<sup>2</sup>, 20 lb)

❖ **Paper Delivery Tray Capacity:**

1,000 sheets (80g/m<sup>2</sup>, 20 lb)

### ❖ Master Eject Unit Capacity:

- A3 drum  
More than 60 masters
- A4 drum  
90 masters

### ❖ Dimensions (W × D × H)

	Width	Depth	Height
Stored	730mm, 28.8"	700mm, 27.6"	585mm, 23"
Stored with document feeder	730mm, 28.8"	700mm, 27.6"	695mm, 27.4"
Set up	1435mm, 56.5"	700mm, 27.6"	585mm, 23"
Set up with cabinet	1435mm, 56.5"	700mm, 27.6"	1,020mm, 40.2"
Set up with cabinet and document feeder (when you use A3, 11" × 17" or larger paper)	1435mm, 56.5"	700mm, 27.6"	1,130mm, 44.5"

### ❖ Weight:

- Machine:  
Less than 97kg, 213.4 lb

### ❖ Noise Emission <sup>\*1</sup>

Sound power level

	Mainframe only
Stand-by	--
During printing	120cpm

Sound pressure level <sup>\*2</sup>

	Mainframe only
Stand-by	--
During printing	120cpm

<sup>\*1</sup> The above measurements made in accordance with ISO 7779 are actual value.

<sup>\*2</sup> It is measured at the position of the operator.

### ❖ Power Consumption:

- Making a master:  
Less than 0.34kW
- Printing:  
Less than 0.25kW

❖ **Optional Equipment:**

- Drum unit: Color Drums  
Type 55(L) A3, 11" × 17"  
Type 55(S) A4, 8<sup>1</sup>/<sub>2</sub>" × 11"
- Document Feeder Type 85

 **Note**

- Specifications are subject to change without notice.

## Document Feeder (Option)

❖ **Original Type:**

Sheet

❖ **Original Weight:**

52.3g/m<sup>2</sup> to 127.9g/m<sup>2</sup>, 13.9 lb to 34 lb

❖ **Original Size:**

Max. 297mm × 864mm, 11.7" × 34.0"

Min. 149mm × 210mm, 5.9" × 8.3"

❖ **Original Capacity:**

50 sheets (80g/m<sup>2</sup>, 20 lb)

7.5mm, 0.3" height

**Color Drum Type 55(L) A3, 11" × 17" (Option)**

**Color Drum Type 55(S) A4, 8<sup>1</sup>/<sub>2</sub>" × 11" (Option)**

**Exposure Glass Cover (Option)**

**Printer Unit Type 80 RCP80 (Option)**

**Interface Cable Type 85 (Option)**

**Editing Function Type 85 (Option)**

# Twin Color Press Roller Printing System TC-II (Option)

❖ **Configuration:**  
Floor standing (with custom table or cabinet)

❖ **Printing Process:**  
Twin color press roller printing system

❖ **Print Paper Size:**  
Maximum: 297mm × 432mm, 11.6" × 17.0"  
Minimum: 70mm × 250mm, 2.8" × 9.8"

❖ **Print Paper Weight:**

- 52.3 – 209.3g/m<sup>2</sup>, 13.9 – 55.6 lb

❖ **Print Speed:**  
90–120cpm (3 steps)

❖ **Color Printing:**  
Drum unit replacement system

❖ **Paper Size and Paper Capacity:**  
1,000 sheets (80g/m<sup>2</sup>, 20 lb)

❖ **Paper Delivery Tray Capacity:**  
1,000 sheets (80g/m<sup>2</sup>, 20 lb)

❖ **Dimensions (W × D × H)**

	Width	Depth	Height
Stored	920 mm, 36.2"	630 mm, 24.8"	555 mm, 21.9"
Set up	1,610 mm, 63.4"	630 mm, 24.8"	555 mm, 21.9"

❖ **Weight:**

- Machine:  
Less than 88kg, 194 lb

❖ **Power Consumption:**

- Printing:  
0.55kW(Max)

❖ **Optional Equipment:**

- Drum unit: color Drums  
A3, 11" × 17"

 **Note**

☐ Specifications are subject to change without notice.



# Consumables

Name	Size	Remarks
Master:	Length: 110m, 363ft/roll Width: 320mm, 12.6" 2 Rolls/case	A3 drum More than 200 masters can be made per roll A4 drum 330 masters can be made per roll
Ink-Black	1,000ml/pack	Environmental conditions: -5 to 40°C 10 – 95% RH
Ink-Red	1,000ml/pack	
Ink-Blue		
Ink-Green		
Ink-Brown		
Ink-Purple		
Ink-Yellow		
Ink-Navy		
Ink-Maroon		
Ink-Teal		
Ink-Orange		
Ink-Gray		
Ink-Violet		
Ink-Hunter green		
Ink-Burgundy		
Ink-Gold		

 **Note**

- Specifications are subject to change without notice.

# INDEX

---

[◀][▶][△][▽], 7

---

- 16 single-sided originals → 1 single-sided print of 16 images, 115
- 1 single-sided original → 1 single-sided print of 2 images, 68
- 1 single-sided originals → 1 single-sided print of 4 images, 68
- 2 single-sided originals → 1 single-sided print with 2 images, 63
- 2 single-sided originals → 1 single-sided print with 4 images, 63
- 4 single-sided originals → 1 single-sided print of 4 images, 115
- 8 single-sided originals → 1 single-sided print of 8 images, 115

## A

---

- A3/11" × 17" drum indicator, 8
- A3/11" × 17" drum unit, 187
- A4/81/2" × 11" drum indicator, 8
- A4/81/2" × 11" drum unit, 187
- accessing the user tools, 139
- Add Ink Indicator (▲), 182
- Adjusting the Image Density of Prints, 25
- Adjusting the Position of Printed Images, 24
- Administrator Mode, 150
- All Class Mode, 52
- Auto Class, 147
- Auto Class Mode, 54
- Auto Combine Mode, 68
- Auto Cycle, 51
- 【Auto Cycle】** key, 7
- Auto Cycle ON/OFF, 144
- Auto Magnification, 31
- 【Auto On Line】** key, 6
- Auto Quality Start, 76
- Auto Reset, 141
- Auto Rotation, 148
- Auto Separate, 147

## B

---

- Background ON/OFF, 145
- Background Patterns, 86
- Black Line/Stain, 192

## C

---

- Cancel, 9
- Cancel Comb., 146
- Changing the Printing Speed, 27
- Check Counter, 150, 164
- Chg. User Code, 150, 165
- Class Enter No., 143, 154
- 【Class】** key, 7
- Class Manual Set, 144
- Class Mode, 61
- Clearing Misfeeds, 171
- 【Clear Modes/Energy Saver】** key, 7
- 【Clear/Stop】** key, 7
- Closed area method, 91
- Color Drum, 130, 187
- Color drum indicator, 8
- Color Printing, 130
- Combination Chart, 135
- Combine, 145
- 【Combine】** key, 6
- Combine Originals, 63
- Combine Printing, 127
- Comb. Sep. Line, 145
- Command Sheet, 87
- Consumables, 205
- CopyCount Display, 142
- Counter, 8

## D

---

- Data In indicator (Green), 8
- Data Print, 142
- Date Position Set, 149
- Date Stamp, 108
- Date Style Set, 149
- Deflector Angle, 147
- Del. User Code, 151, 166
- Diagonal line method, 89
- Directional Magnification (%), 36
- Directional Magnification (Size), 38
- Direction(Page), 149
- Dirty Background, 189
- Document feeder (ADF), 4
- Drum Size, 134
- Drum unit, 3
- drum unit handle B2, 131
- Drum unit lock lever B1, 3

## E

---

Eco.Mode ON/OFF, 144  
Economy Mode, 50  
**【Economy Mode】** key, 6  
Edge Erase, 41  
**【Edge Erase】** key, 6  
Energy Saver Mode, 22  
Energy Saving, 142  
envelopes, 44  
Environment, 195  
Erasing Center and Edge Margins, 40  
Error indicator (Red), 8  
Ethernet Speed, 152  
Exit, 9  
Exposure Glass, 3  
Exposure glass cover, 3

## F

---

Flip up cover, 1  
Format, 105  
Front door, 1

## H

---

Handle E1, 2

## I

---

Idling for Q.start, 146  
Ignore Paper Size, 144  
**【Image Density】** key, 6  
Image Overlay, 105  
Image Rotation, 82  
Indicators, 8  
Initial Setting, 143  
Ink, 182, 205  
Ink holder, 3  
Ink/Master Left, 147  
I/O Buffer, 152  
I/O Timeout, 152  
IP Address, 152

## J

---

Job Separation, 77  
**【Job Separator】** key, 6

## K

---

key counter, 187  
Key Operator Code, 151  
Keys, 6



## L

---

Language on LCD, 141  
LCD Contrast, 142  
Letter mode, 46  
Letter/Photo Mode Printing, 46  
List/Test Print, 151  
Loading Paper, 15, 170  
Load Paper indicator () , 170  
Longer Paper, 145  
LT/Photo Contrast, 143  
LT/Photo Priority, 143

## M

---

Machine Clearance, 196  
Machine Exterior, 1  
Machine Interior, 2  
Main switch, 2  
Maintaining Your Machine, 197  
Make/Chg. Pattern, 149, 163  
**【Make-Up】** key, 6  
Make-up Printing, 94  
Make-up Printing Features, 83  
Make-up Samples, 97  
Manual Class Mode with One Original, 57  
Manual Class Mode with Two or More  
Originals, 59, 128  
Manual Quality Start, 76  
Master, 184, 205  
Master Eject Indicator () , 186  
Master End Indicator () , 184  
Master length, 79, 148  
Master Misfeeds in the Master Eject  
Section, 177, 178  
Master Misfeeds in the Master Feed  
Section, 176  
Master tray, 1  
Max. Quantity, 142  
Memory Combine, 115  
Menu Reset, 152  
Min. Quantity, 142  
mm/inch, 141  
Mode Setting, 144  
Monitor indicators, 8  
MSTR Makg. Density, 143

## N

---

Network, 152  
Next, 9  
No. of Q.start, 146, 157  
No. of Skip Feed, 146, 156  
No Orig. Size, 145  
No Orig. Size DF, 144  
Number keys, 7

## O

---

OK, 9  
**【On Line】** key, 6  
On Line overlay, 105  
On Line Printing, 80  
Open Cover/Unit Indicator (☑\*), 181  
Operation Panel, 1, 6  
Optional Document Feeder, 125  
Options, 4, 202, 203  
Original Misfeeds, 179  
Original Modes, 46  
Original Priority, 143  
Originals, 13, 125  
Overlay, 105  
**【Overlay】** key, 6

## P

---

Page Stamp, 110  
Panel Beeper, 142  
Panel Display, 8, 9  
Panel Display Layout, 10  
Paper alignment wings, 2  
Paper delivery end plate, 2  
Paper delivery side plates, 2  
Paper delivery tray, 2  
Paper feed side plates, 1  
Paper feed side plates knob, 1  
Paper feed tray, 1  
Paper feed tray down key, 1  
Paper Misfeeds in the Paper Exit Section, 175  
Paper Misfeeds in the Paper Feed Section, 171, 172  
Paper or Master Wrapped Around the Drum, 173  
Paper Type, 43, 44, 45, 143  
PC controller, 80, 106  
Pencil Mode Printing, 48  
Photo Contrast, 144  
Photo Mode Printing, 47  
Photo(Screen), 144

Poor Printing, 189  
Position(Date), 149  
Position(Page), 149  
Power Connection, 196  
Prev., 9  
Printing in Two Colors, 132  
**【Print】** key, 7  
Print Paper, 11, 43, 170  
Print PS Errors, 151  
**【Program】** key, 7  
Programs, 72  
**【Proof】** key, 7  
Protecting a Program, 73

## Q

---

**【#】** key, 7  
**【Quality Start】** key, 6  
Quality Start Mode, 76

## R

---

R. Cntr. Display, 141  
Recalling a Program, 74  
Reducing and Enlarging Using Preset Ratios, 29  
Reg/Chg KeyOpCode, 151  
Reg. User Code, 150  
Remarks, 193  
Removing Program Protection, 73  
Repeat, 120  
Repeating an image over the entire print, 115  
Reproduction Ratio, 154  
Reproduct'n Ratio, 143  
Reset Counters, 150, 164  
Reset R. Counter, 141  
Restricted Access, 151

## S

---

Safety Information, i  
**【Security】** key, 6  
Security Mode, 75  
Select, 9  
service call, 168  
Set Operat'n Mode, 142  
Setting Q.start, 146  
Setting Up The Paper Delivery Tray, 16  
Set User Code, 150  
Size, 148  
**【Skip Feed】** key, 6  
Skip Feed Printing, 70  
Special feature indicator, 8

special kinds of paper, 44  
Specifications, 199  
Stamp, 113, 148  
Stamp Density, 148  
**【Stamp】** key, 6  
Stamp Position, 148, 159  
Standard Paper, 43  
Standard Printing, 19  
**【Start】** key, 7  
Stopping a Multi-print Run, 28  
Storage Overlay, 105  
Storing a Program, 72  
System, 141

## T

---

Thick Paper, 43  
Time Setting, 141, 153  
Tint Mode, 26  
Trailing edge guides, 3  
Troubleshooting, 167  
Type, 148  
Type of Paper, 147, 158  
Type(Page), 149

## U

---

User Code, 18, 150  
User Tools, 139  
**【User Tools】** key, 6  
User Tools Menu, 141

## W

---

What You Can do with this Machine, vi  
when the image density is too light, 192  
Where to Put Your Machine, 195  
**【◀】【▶】** keys (Speed keys), 7

## Z

---

Zoom, 34





MEMO



  
  
**Operating Instructions**